

Multi Units of Three Phase Photovoltaic using Band Pass Filter to Enhance Power Quality in Distribution Network under Variable Temperature and Solar Irradiance Level

By Amirullah Amirullah

Multi Units of Three Phase Photovoltaic using Band Pass Filter to Enhance Power Quality in Distribution Network under Variable Temperature and Solar Irradiance Level

Adiananda, Agus Kiswantono, Amirullah

Study Program of Electrical Engineering, Faculty of Engineering, University of Bhayangkara Surabaya, Indonesia

Article Info

Article history:

Received Sep 6, 2017

Revised Dec 22, 2017

Accepted Dec 29, 2017

Keyword:

Band pass filter
Harmonics
Irradiance
Multi photovoltaic
Temperature
Unbalance

ABSTRACT

The paper proposed power quality enhancement on three phase grid of point common coupling (PCC) bus due to integration of multi units of photovoltaic (PV) to 380 volt (phase-phase) 50 Hz low voltage distribution network under variable temperature and irradiance level. The band pass filter models (single tuned and double tuned) were installed to improvement power quality on the conditions i.e. without filter, with single tuned filter, and with double tuned filter. Multi units of PV generator without filter, with single tuned, and with double tuned filter at all temperatures and irradiance levels resulted in relatively stable phase voltage (308 and 310 volt), so able to generate an unbalanced voltage of 0%. The maximum phase current for the system without filter at all temperatures and radiation levels of 9.8, 12.5, and 10 ampere respectively, resulted in an unbalanced current of 16.10%. Under the same condition, single tuned and double tuned filters were able to balance phase current to 10.45 A and 10.44 ampere respectively, resulting in an unbalanced current of 0%. Implementation of single tuned and double tuned filters was able to reduce unbalance current according to ANSI/IEEE 241-1990. At constant temperature and irradiance increased, both average voltage and current harmonics also increased. Double tuned active filter was the most effective to suppress the 11th and 13th harmonics so that capable to mitigate average voltage and current harmonics better than system using single tuned filter which could only reduce 5th harmonic within IEEE 519-1992.

Copyright © 2018 Institute of Advanced Engineering and Science.
All rights reserved.

Corresponding Author:

Adiananda,
Study Program of Electrical Engineering,
Faculty of Engineering,
University of Bhayangkara Surabaya,
Jl. Ahmad Yani 114, Surabaya 60231, East Java Province, Indonesia.
Email: adiananda@ubhara.ac.id, adi.dirza@gmail.com

1. INTRODUCTION

The PV beside being able to generate power, it also results harmonics due to inverter as a medium to convert DC into AC voltage so can decrease power quality. Randomly installed PV generators in low voltage distribution network (grid) are also able to deliver unbalanced line current. This renewable energy based DGs also has intermittent characteristics and produces power depend on environmental condition i.e. temperature and solar irradiation level. The research on power quality of PV generator connected grid to power system using LCL filter has been done Kon Keng Weng et. al. A number of power quality problems i.e. over voltage, less voltage, power fluctuations, inrush currents, low power factor, and current harmonics or total harmonics distortion (THD) will appear on microgrid power systems. This research is conducted only on constant solar irradiance and temperature condition (1000 W/m^2 and 25^0 C) as environmental input parameters for PV systems [1]. The study on effect of solar radiation on grid connected to PV generator to power quality i.e.

voltage/current harmonics, active/reactive power, and power factor correction has been investigated by Minas Patsalides, et.al. It considers two different scenarios of average and low radiation. The shortcoming is not to consider effect of temperature as an input variable for PV generator [2]. Investigation of grid connected a single phase PV generator inverter using a current proportional resonant, proportional resonant integral, and genetic algorithm using an active filter to reduce current harmonics of inverter output has been studied by Renu et. al. The laxity of research is only done on a single phase system as well as certain solar irradiation and temperature [3].

The dynamic analysis of power quality due to high penetration effect of distribution network connected to PV system under variable solar irradiance has been studied by Massoud Farhoodnea, et. al. It was performed on a 16 bus system model and the result showed that high level penetration of grid connected PV will cause a number of power quality problems i.e. swell/flicker voltage, loss power factor and current harmonics. The system is only analyzed on voltage harmonics and did not consider the ambient temperature condition [4]. Power quality characteristics in a number of three phase PV inverters at top roof PV i.e. harmonics distortion, voltage fluctuation, reactive power and power factor have been performed by K.P. Kontogianis, et. al [5]. The investigation of a three phase grid connected to a PV generator using maximum power point tracking (MPPT) with perturb and observe (P and O) algorithm and voltage source inverter controller, as well as its effect on current harmonics injected into the grid and a grid voltage harmonic has been investigated by Almas Hossain Mollah et.al. The research are only carried out at single irradiance and temperature (1000 W/m² and 25 °C) and did not consider voltage/current harmonics mitigation according to IEEE 519-1992 [6]. The effect of PV generator integration on power quality on three phase grid PCC bus under variable solar irradiance using double tuned filters has been studied by Amirullah et. al. The results shows that at a fixed solar radiation level, the more a number of PV generators connected to three phase grid, average THD of grid voltage/current increased. Otherwise at level of solar irradiance increased, average THD of grid voltage/current also increased. Double tuned passive filter can reduce average THD of grid voltage/current. However, the research is carried out at a fixed temperature level of 40°C, whereas the fact indicates that ambient temperature and solar irradiance are the main input variable for PV generator whose values are always changing with time [7]. A combined system of a three-phase four-wire shunt active power filter (SAPF), and photovoltaic generator (PVG) have been proposed by Richid Belaidi, et.al. The PVG-SAPF is capable to solve the power quality problems such as reduce harmonic current, compensate reactive power for power factor correction, and unbalance load, as well as inject the issued energy from the PVG into the utility grid. However, the power quality parameter analysis in this paper was only performed by using single PVG [8]. The method for balancing line current and voltage, due to the presence of DGs i.e. a number of single phase PV generation units in homes has been presented by Amirullah, et.al. The single phase PV generator is installed randomly on a 220 kV and 50 Hz three phase four wire distribution network using battery energy storage (BES) and three single phase bidirectional inverter circuits. The result shows that the combination of BES and three single phase bidirectional inverter are able to reduce unbalanced line current/voltage. Otherwise, the combination of both circuit is able to increase current/voltage harmonics [9].

This paper presents enhancement of power quality performance due to integration of multi units PV generator using a band pass filter to 380 kV (phase-phase) 50 Hz low frequency distribution network on PCC bus under variable temperature and solar irradiance level. The model is composed of three PV generators group with 100 kW active power. Beside connect to three phase grid, PV generators are also linked to three groups of three phase loads each having 20 kW active power. Power quality studied are voltage and current unbalance as well as voltage and current harmonics in 12 scenarios on PV generator connected PCC bus of three phase grid. The band pass filter models (single tuned and double tuned) are installed to enhance power quality on the conditions i.e. without filter, with single tuned filter, and with double tuned filter. The results are further validated with ANSI/IEEE 241-1990 (voltage and current unbalance) and IEEE 519-1992 for (voltage and current THD), as a base to determine power quality level. Simulation and analysis results use Matlab/Simulink environment.

The rest of paper is organized as follow. Section 2 presents research method i.e. proposed model of single PV generator with band pass filter, model multi units of PV generator, simulation parameters, equivalent circuit and mathematical of PV model, harmonics and voltage/current unbalance, and band pass filter model. Section 3 describes influence of variable solar irradiance and temperature level of three model generator to voltage and current unbalance as well as voltage and current THD, without filter, with single tuned filter, and double tuned filter. In this section, example cases studied are presented and its results are verified with those of Matlab/Simulink. Finally, the paper is concluded in Section 4.

2. RESEARCH METHOD

2.1. Proposed Method

The model of a single 100 kW PV generator connected to a three phase grid is shown in Figure 1. The PV system produces output voltage become as input for the DC/DC converter. The MPPT with P and O algorithm is single phase PV generator resulting maximum power. The low DC output voltage from PV generator is increased by DC/DC boost converter to produce output voltage by adjusting duty cycle by switching device. The DC output is further converted by a three phase DC/AC inverter circuit to an AC voltage to a three phase grid using six insulated gate bipolar transistors (IGBTs) circuit base on pulse width modulation (PWM). Figure 2 shows proposed model of three groups of PV generator linked to a 380 volt (phase-phase), 50 Hz three phase low voltage distribution network on PCC bus and a 100 MVA, 20 kV three phase grid through a 100 kVA, 20 kV/380 V three phase power transformer.

This paper performs power quality enhancement on three phase grid of PCC bus due to integration of PV generator to 220 kV 50 Hz low voltage distribution network under variable temperature and irradiance level. The research uses three group models PV generator each with 100 kW active power. The power quality parameters are voltage and current unbalance, as well as voltage and current harmonics in 12 PV generator scenarios connected distribution network on PCC bus. The first scenario is without filter at the irradiance level i.e. 400 W/m², 600 W/m², 800 W/m², and 1000 W/m². The second and third scenarios are with single tuned filter and double tuned filter at the same irradiance level respectively. The temperature degree of each condition are 20^o, 25^o, 30^o, 35^o, and 40^o Celcius. So that the total scenarios are 12 different irradiation levels (without filter, with single tuned filter, and with double tuned filter) where it has five temperatures degree.

The simulation is performed to determine voltage and current waveform of a three phase distribution network on PCC bus. The band pass filter model i.e. single tuned and double tuned is used to improve power quality performance. The single tuned filter serves to suppress 5th single harmonic while double tuned filter expected to reduce 11th and 13th harmonics. A three phase phase circuit breaker (CB) is used to connect and disconnect band pass filter between a single PV generator and a three phase grid. The next process is to determine unbalance voltage and current as well as voltage and current THD in each scenario. Its results are further validated with ANSI/IEEE 241-1990 (unbalance voltage and current) and IEEE 519-1992 (voltage and current THD) as the basis for determining power quality level. Simulation and analysis of research results use Matlab/Simulink.

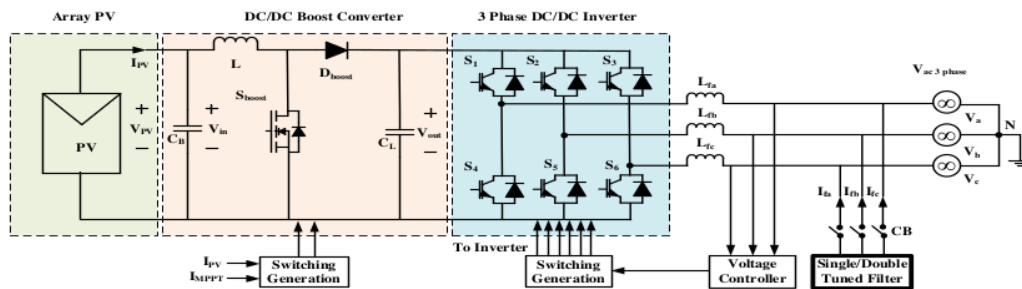

Figure 1. Model of single PV generator connected three phase grid with band pass filter

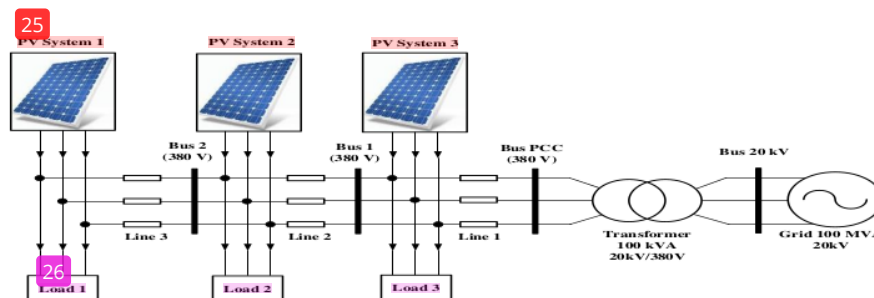

Figure 2. Proposed model of multi units of PV generator connected to three phase grid

Table 1 shows the devices, parameters, and simulation values of proposed model.

Table 1. Simulation Parameters

No.	Devices	Parameters	Values
1.	PV Generator 1, 2, and 3	Active Power	100 kW
		Temperature	20 ^o , 25 ^o , 30 ^o , 35 ^o , and 40 ^o C
		Irradiance	400, 600, 800, and 1000 W/m ²
2.	Three Phase Grid	Short Circuit MVA	100 MVA
		Voltage (phase-phase)	380 volt
		Frequency	50 Hz
3.	Power Transformer	Power	100 kVA
		Frequency	50 Hz
		Voltage	380 Volt/20 kV
4.	Load 1, 2, and 3	Active Power	20 kW
		Voltage	380 Volt
		Frequency	50 Hz
5.	Low Voltage Line 1, 2, and 3	Resistance	R = 0,1273 Ohm/km
		Inductance	L = 93.37 mH/km
		Capacitance	C = 1,274 μF/km
6.	Length of Low Voltage Line 1, 2, and 3	Line 1	1 km
		Line 2	1 km
		Line 3	1 km
7.	DC Link Capasitor	Capacitance	2000 μF
8.	PWM Generator on Each PV	Frequency	4 kHz
		Sampling time	5 x 10 ⁻⁶ detik
9.	Single Tuned Filter	Reactive Power	50 MVAR
		Voltage (phase-phase)	380 V
		Frequency System	50 Hz
		Frequency Tuning	f = 5 x 50 Hz
		Quality Factor (Q)	16
10.	Double Tuned Filter	Reactive Power	50 MVAR
		Voltage (phase-phase)	380 V
		Frequency System	50 Hz
		Frequency Tuning	f ₁ = 11 x 50 Hz, f ₂ = 13 x 50 Hz
		Quality Factor (Q)	16

2.1. Photovoltaic Model

Figure 3 shows the equivalent circuit of a solar panel. A solar panel is composed of several PV cells that have series, parallel, or series-parallel external connections [10].

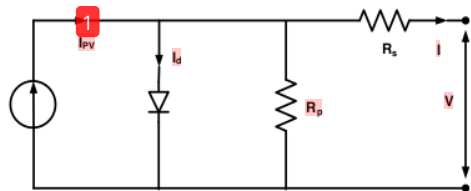

Figure 3. Equivalent circuit of solar panel

The V-I characteristic of a solar panel is showed in (1):

$$I = I_{pv} - I_o \left[\exp\left(\frac{V + R_s I}{aV_t}\right) - 1 \right] - \frac{V + R_s I}{R_p} \tag{1}$$

where I_{pv} is the photovoltaic current, I_o is saturated reverse current, 'a' is the ideal diode constant, $V_t = N_s K T q^{-1}$ is the thermal voltage, N_s is the number of series cells, q is the electron charge, K is the Boltzmann constant, T is the temperature of p-n junction, R_s and R_p are series and parallel equivalent resistance of the solar panels. I_{pv} has a linear relation with light intensity and also varies with temperature

variations. I_o is dependent on temperature variations. The values of I_{pv} and I_o are calculated as following (2) and (3):

$$I_{pv} = (I_{pv,n} + K_1 \Delta T) \frac{G}{G_n} \quad (2)$$

$$I_o = \frac{I_{sc,n} + K_1 \Delta T}{\exp(V_{oc,n} + K_V \Delta T) / aV_i - 1} \quad (3)$$

In which $I_{pv,n}$, $I_{sc,n}$ and $V_{oc,n}$ are photovoltaic current, short circuit current and open circuit voltage in standard conditions ($T_n = 25$ C and $G_n = 1000$ Wm⁻²) respectively. K_1 is the coefficient of short circuit current to temperature, $\Delta T = T - T_n$ is the temperature deviation from standard temperature, G is the light intensity and K_V is the ratio coefficient of open circuit voltage to temperature. Open circuit voltage, short circuit current and voltage-current corresponding to the maximum power are three important points of I-V characteristic of solar panel. These points are changed by variations of atmospheric conditions. By using (4) and (5) which are derived from PV model equations, short circuit current and open circuit voltage can be calculated in different atmospheric conditions.

$$I_{sc} = (I_{sc} + K_1 \Delta T) \frac{G}{G_n} \quad (4)$$

$$V_{oc} = V_{oc} + K_V \Delta T \quad (5)$$

2.2. Voltage/Current and Unbalance Harmonics

Power quality means quality of voltage and current. Power quality is determined based on the voltage and current value or the tolerance limit of equipment used. In general, current and voltage wave form of pure sinusoidal waves. One problem that occurs is non sinusoidal or distorted current and voltage waves generated by harmonics in the power system [11]. Harmonic is distorted periodic steady state wave caused by the interaction between the shape of a sine wave at the fundamental frequency system with another wave component which is an integer multiples frequency of fundamental frequency. The most common harmonic index, which relates to the voltage waveform, is THD, which is defined as the root mean square (rms) of the harmonics expressed as a percentage of the fundamental component as showed in (12). For most applications, it is sufficient to consider the harmonic range from the 2nd to 25th, but most standards specify up to the 50th. Second harmonic index is current THD means the ratio of rms harmonic current value to rms fundamental current which expressed in (7) [11].

$$THD_V = \frac{\sqrt{\sum_{n=2}^N V_n^2}}{V_1} \times 100 \% \quad (6)$$

$$THD_I = \frac{\sqrt{\sum_{n=2}^N I_n^2}}{I_1} \times 100 \% \quad (7)$$

Where V_n and I_n (the rms voltage and current at harmonic n), V_1 and I_1 (the fundamental rms voltage and current), N (the maximum harmonic order to be considered). The allowable maximum THD value for each country is different depending on the standard used. THD standards most often used in electric power system is IEEE 519-1992. There are two criteria used in the analysis of harmonic distortion that voltage distortion limit and current distortion limit [13].

There are several standards that can be used to determine level of voltage unbalance in three phase systems, e.g. IEC, NEMA, and IEEE. In this study, value of unbalance voltage use Equation 8 is based ANSI/IEEE 241-1990 Standard [14] as follows:

$$V(\%) = \frac{|V_{average} - V_{a,b,c \text{ min or max}}|}{V_{average}} \times 100 \% \quad (8)$$

By using Equation (8), value of unbalance voltage expressed in percent (%) and is defined as follows; $V_{average}$ is the average value of maximum voltage on phase a, b, c, (volt), $V_{a,b,c, min}$ is minimum voltage on phase a, b, c, (volt), $V_{a,b,c, max}$ is maximum voltage on phase a, b, c (volt). By using the same equation, then percentage of unbalance current can be calculated by replacing voltage magnitude into current magnitude.

2.3. Band Pass Filter

The shunt passive filters always considered as good solution to solve harmonics current problems. Shunt passive filters can be classified into three basic categories as follows (a) Band pass filters (of single or double tuned), (b) High pass filters (of first, second, third-order or C-t), and (c) Composite filters as shown in Figure 4 [7]. There are two models of band pass filter, i.e. single tuned filter and double tuned filter. A single tuned filter consisting of inductor L, capacitor C and small damping resistor R are connected in parallel with non-linear loads to provide low impedance paths for specific harmonic frequencies, thus resulting in absorbing the dominant harmonic currents flowing out of the load. Furthermore it also compensates reactive power at system operating frequency [15]. Single tuned passive filters are used to suppress harmonic at a single frequency e.g. 5th, 7th, 9th, 11th, or 13th harmonic. Whereas double tuned passive filter is used to eliminate harmonic at two frequencies such as the 5th and 7th harmonics or the 11th and 13th harmonics [16]. In this paper a single tuned filter and double tuned filter model are used to reduce 5th harmonics as well as 11th and 13th harmonics respectively.

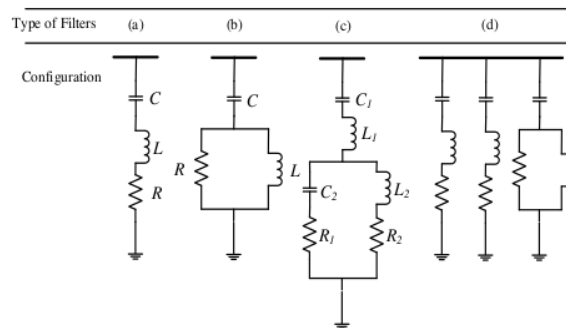

Figure 4. Models of passive filters: (a) band pass, (b) high pass, (c) double band pass, (d) composite

3. RESULTS AND ANALYSIS

The results analysis is began from determination of maximum and minimum grid voltages in each phase, to compute unbalanced voltage using Equation 8, as well as voltage THD of three phase grid on PCC bus without, with single tuned filter, and with double tuned filter respectively. By using the same procedure and equation, then obtained unbalance current and current THD. Table 2 represents unbalanced voltage and average voltage harmonics (THD_V) in three PV generator integration model to a three phase grid and four levels of irradiance with five different temperature levels. Table 3 shows the unbalanced current and average harmonic current (THD_I) on the PCC bus under the same condition.

Table 2. Unbalance Voltage and Average Voltage Harmonics

No.	Irradiance Level (W/m ²)	Temp (°C)	Maximum Voltage (V)			Unbalance Voltage (%)	THD _V (%)			Average THD _V (%)
			A	B	C		A	B	C	
Without Filter										
1.	400	20	308	308	308	0	2.66	2.51	2.59	2.59
		25	308	308	308	0	2.62	2.56	2.56	2.58
		30	308	308	308	0	2.69	2.60	2.63	2.64
		35	310	310	310	0	2.67	2.53	2.59	2.60
		40	310	310	310	0	2.68	2.58	2.62	2.62
2.	600	20	308	308	308	0	3.59	3.60	3.63	3.61
		25	308	308	308	0	3.70	3.64	3.61	3.65
		30	308	308	308	0	3.61	3.55	3.49	3.55
		35	310	310	310	0	3.66	3.56	3.55	3.59
		40	310	310	310	0	3.66	3.60	3.54	3.60
3.	800	20	310	310	310	0	4.16	4.19	4.06	4.14

No.	Irradiance Level (W/m ²)	Temp (°C)	Maximum Voltage (V)			Unbalance Voltage (%)	THDV (%)			Average THD _v (%)		
			A	B	C		A	B	C			
Without Filter												
4.	1000	25	310	310	310	0	4.21	4.21	4.12	4.18		
		30	310	310	310	0	4.12	4.14	3.99	4.11		
		35	310	310	310	0	4.16	4.14	4.06	4.12		
		40	310	310	310	0	4.11	4.14	4.03	4.10		
		20	310	310	310	0	4.12	4.08	4.01	4.07		
		25	310	310	310	0	4.15	4.07	3.98	4.06		
		30	310	310	310	0	4.04	3.99	3.93	3.98		
		35	310	310	310	0	4.03	3.94	3.90	3.96		
1.	400	40	310	310	310	0	4.03	3.90	3.90	3.94		
		With Single Tuned Filter										
		20	308	308	308	0	0.22	0.23	0.22	0.22		
		25	308	308	308	0	0.22	0.23	0.23	0.23		
		30	308	308	308	0	0.23	0.23	0.22	0.23		
		35	310	310	310	0	0.23	0.23	0.23	0.23		
		40	310	310	310	0	0.23	0.23	0.23	0.23		
		2.	600	20	308	308	308	0	0.33	0.33	0.34	0.33
25	308			308	308	0	0.34	0.34	0.34	0.34		
30	308			308	308	0	0.34	0.34	0.34	0.34		
35	310			310	310	0	0.34	0.33	0.34	0.34		
40	310			310	310	0	0.35	0.34	0.35	0.35		
3.	800			20	308	308	308	0	0.42	0.43	0.43	0.43
				25	308	308	308	0	0.43	0.43	0.43	0.43
				30	308	308	308	0	0.43	0.41	0.43	0.42
		35	310	310	310	0	0.42	0.42	0.42	0.42		
		40	310	310	310	0	0.43	0.42	0.43	0.43		
		4.	1000	20	310	310	310	0	0.43	0.43	0.43	0.43
				25	310	310	310	0	0.41	0.42	0.43	0.42
				30	310	310	310	0	0.42	0.42	0.42	0.42
35	310			310	310	0	0.41	0.42	0.42	0.42		
40	310			310	310	0	0.41	0.42	0.42	0.42		
With Double Tuned Filter												
1.	400			20	307.8	307.8	307.8	0	0.09	0.09	0.10	0.09
				25	307.8	307.8	307.8	0	0.10	0.09	0.10	0.10
		30	307.8	307.8	307.8	0	0.10	0.09	0.10	0.10		
		35	307.8	307.8	307.8	0	0.09	0.09	0.10	0.09		
		40	307.8	307.8	307.8	0	0.09	0.09	0.10	0.09		
		2.	600	20	307.8	307.8	307.8	0	0.14	0.13	0.15	0.14
				25	307.8	307.8	307.8	0	0.15	0.13	0.15	0.14
				30	307.8	307.8	307.8	0	0.15	0.13	0.15	0.14
35	307.8			307.8	307.8	0	0.15	0.13	0.15	0.14		
40	307.8			307.8	307.8	0	0.15	0.13	0.15	0.14		
3.	800			20	307.8	307.8	307.8	0	0.19	0.17	0.19	0.18
				25	307.8	307.8	307.8	0	0.18	0.17	0.19	0.18
				30	307.8	307.8	307.8	0	0.18	0.16	0.18	0.17
		35	307.8	307.8	307.8	0	0.18	0.16	0.19	0.18		
		40	307.8	307.8	307.8	0	0.18	0.16	0.18	0.17		
		4.	1000	20	307.8	307.8	307.8	0	0.18	0.17	0.19	0.18
				25	307.8	307.8	307.8	0	0.18	0.17	0.19	0.18
				30	307.8	307.8	307.8	0	0.18	0.17	0.19	0.18
35	307.8			307.8	307.8	0	0.18	0.16	0.18	0.17		
40	307.8			307.8	307.8	0	0.18	0.17	0.18	0.18		

Table 3. Unbalance Current and Average Current Harmonics

No.	Irradiance Level (W/m ²)	Temp (°C)	Maximum Current (A)			Unbalance Current (%)	THD _i (%)			Average THD _i (%)
			A	B	C		A	B	C	
Without Filter										
1.	400	20	9.8	12.5	10	16.10	2.01	1.27	1.69	1.657
		25	9.8	12.5	10	16.10	2.02	1.26	1.68	1.654
		30	9.8	12.5	10	16.10	2.01	1.27	1.68	1.653
		35	9.8	12.5	10	16.10	2.02	1.27	1.70	1.663
		40	9.8	12.5	10	16.10	2.02	1.27	1.70	1.663
2.	600	20	9.8	12.5	10	16.10	2.28	1.47	1.93	1.893
		25	9.8	12.5	10	16.10	2.03	1.15	1.93	1.704
		30	9.8	12.5	10	16.10	2.01	1.27	1.68	1.653
		35	9.8	12.5	10	16.10	2.02	1.27	1.70	1.663
		40	9.8	12.5	10	16.10	2.02	1.27	1.70	1.663
3.	800	20	9.8	12.5	10	16.10	2.29	1.57	1.95	1.937
		25	9.8	12.5	10	16.10	2.30	1.56	1.95	1.936
		30	9.8	12.5	10	16.10	2.29	1.55	1.95	1.930

No.	Irradiance Level (W/m ²)	Temp (°C)	Maximum Current (A)			Unbalance Current (%)	THD _i (%)			Average THD _i (%)		
			A	B	C		A	B	C			
Without Filter												
4.	1000	35	9.8	12.5	10	16.10	2.29	1.55	1.95	1.930		
		40	9.8	12.5	10	16.10	2.29	1.55	1.93	1.923		
		20	9.8	12.5	10	16.10	2.36	1.63	1.88	1.957		
		25	9.8	12.5	10	16.10	2.16	1.30	2.01	1.824		
		30	9.8	12.5	10	16.10	2.34	1.63	1.87	1.947		
		35	9.8	12.5	10	16.10	2.32	1.62	1.86	1.933		
1.	400	40	9.8	12.5	10	16.10	2.32	1.61	1.83	1.920		
		With Single Tuned Filter										
		20	10.45	10.45	10.45	0	0.09	0.09	0.09	0.09		
		25	10.45	10.45	10.45	0	0.09	0.09	0.09	0.09		
		30	10.45	10.45	10.45	0	0.09	0.09	0.09	0.09		
		35	10.45	10.45	10.45	0	0.09	0.09	0.09	0.09		
2.	600	40	10.45	10.45	10.45	0	0.09	0.09	0.09	0.09		
		20	10.45	10.45	10.45	0	0.13	0.13	0.13	0.13		
		25	10.45	10.45	10.45	0	0.13	0.13	0.13	0.13		
		30	10.45	10.45	10.45	0	0.13	0.13	0.13	0.13		
		35	10.45	10.45	10.45	0	0.13	0.13	0.13	0.13		
		40	10.45	10.45	10.45	0	0.13	0.13	0.13	0.13		
3.	800	20	10.45	10.45	10.45	0	0.17	0.17	0.17	0.17		
		25	10.45	10.45	10.45	0	0.17	0.17	0.16	0.17		
		30	10.45	10.45	10.45	0	0.17	0.17	0.17	0.17		
		35	10.45	10.45	10.45	0	0.17	0.17	0.16	0.17		
		40	10.45	10.45	10.45	0	0.17	0.16	0.16	0.16		
		40	10.45	10.45	10.45	0	0.16	0.16	0.16	0.16		
4.	1000	20	10.45	10.45	10.45	0	0.17	0.17	0.17	0.17		
		25	10.45	10.45	10.45	0	0.17	0.17	0.17	0.17		
		30	10.45	10.45	10.45	0	0.16	0.16	0.16	0.16		
		35	10.45	10.45	10.45	0	0.16	0.16	0.16	0.16		
		40	10.45	10.45	10.45	0	0.16	0.16	0.16	0.16		
		40	10.45	10.45	10.45	0	0.16	0.16	0.16	0.16		
With Double Tuned Filter												
1.	400	20	10.44	10.44	10.44	0	0.03	0.02	0.03	0.03		
		25	10.44	10.44	10.44	0	0.03	0.02	0.03	0.03		
		30	10.44	10.44	10.44	0	0.03	0.02	0.03	0.03		
		35	10.44	10.44	10.44	0	0.03	0.02	0.03	0.03		
		40	10.44	10.44	10.44	0	0.03	0.02	0.03	0.03		
		40	10.44	10.44	10.44	0	0.03	0.02	0.03	0.03		
2	600	20	10.44	10.44	10.44	0	0.04	0.03	0.04	0.04		
		25	10.44	10.44	10.44	0	0.04	0.03	0.05	0.04		
		30	10.44	10.44	10.44	0	0.04	0.03	0.04	0.04		
		35	10.44	10.44	10.44	0	0.04	0.03	0.04	0.04		
		40	10.44	10.44	10.44	0	0.04	0.03	0.04	0.04		
		40	10.44	10.44	10.44	0	0.04	0.03	0.04	0.04		
3	800	20	10.44	10.44	10.44	0	0.05	0.04	0.05	0.05		
		25	10.44	10.44	10.44	0	0.05	0.04	0.05	0.05		
		30	10.44	10.44	10.44	0	0.05	0.04	0.05	0.05		
		35	10.44	10.44	10.44	0	0.05	0.04	0.06	0.05		
		40	10.44	10.44	10.44	0	0.05	0.04	0.05	0.05		
		40	10.44	10.44	10.44	0	0.05	0.04	0.06	0.05		
4	1000	20	10.44	10.44	10.44	0	0.05	0.04	0.06	0.05		
		25	10.44	10.44	10.44	0	0.05	0.04	0.06	0.05		
		30	10.44	10.44	10.44	0	0.05	0.04	0.06	0.05		
		35	10.44	10.44	10.44	0	0.05	0.04	0.06	0.05		
		40	10.44	10.44	10.44	0	0.05	0.04	0.06	0.05		
		40	10.44	10.44	10.44	0	0.05	0.04	0.05	0.05		

Figure 5 shows a grid voltage waveform of PV generator model connected three phase grid on two levels of solar irradiance (600 W/m² and 1000 W/m²) on PCC bus without filter, with single tuned filter, and double tuned filter.

Figure 6 shows harmonics spectra of grid voltage of PV generator model connected three phase grid on two levels of solar irradiance (600 W/m² and 1000 W/m²) on PCC bus without filter, with single tuned filter, and with double tuned filter.

Figure 7 shows performance of voltage and current average harmonics in three PV generator model connected three phase grids on PCC bus at four levels of irradiance (temperature 25⁰ C), without filter, with single tuned filter, and with double tuned filter.

Table 3 shows that maximum voltages (phase A, B, and C), the system without filter for all irradiance levels (400 to 1000 W/m²) and temperatures (20 to 40⁰C) are stable at 308 and 310 volt, so it generates an unbalanced voltage of 0%. The maximum phase voltage of system using a single tuned filter for all irradiance levels and temperatures (20⁰C, 25⁰C, and 30⁰C) is equal to 308 volt and at temperatures (35⁰C and 40⁰C), the value increases to 310 volt, resulting in same an unbalance voltage of 0%. The same value using a double tuned filter at all radiation levels (400 to 1000 W/m²) and temperature (20⁰C to 40⁰C) is equal to 307.8 volt, resulting in same an unbalanced voltage of 0%. Under the condition without filter, irradiance

level remains, and temperature increases, average voltage harmonics (THD_V) is relatively the same. While for the condition without filter and fixed temperature, but irradiance level increases, then average voltage harmonics also increases. The lowest average voltage harmonics is generated at irradiance of 400 W/m^2 and temperature of 25°C as 2.58%, while the highest occurs at irradiance of 800 W/m^2 and temperature of 25°C as 4.18%. Under the condition of using single tuned filter, irradiance remains, and temperature increases, then average voltage harmonics is relative same. Under the condition of without filter, fixed temperature, but irradiance increase, then average voltage harmonics also increases. The lowest average voltage harmonics is generated at irradiance 400 W/m^2 and temperature 20°C as 0.22%, while the highest harmonics occurs at irradiance of 800 W/m^2 and temperature of 25°C as 0.43%. Application of double tuned filter at fixed irradiance and increased temperature produces relatively same average voltage harmonics. On the other hand, at constant temperature and irradiance, so that average voltage harmonics increases. The lowest average voltage harmonics is generated at irradiance of 400 W/m^2 and temperature of 20°C as 0.09%, while the highest occurs at irradiance of 1000 W/m^2 and temperature of 25°C as 0.18%. The use of double tuned filter can suppress 11th and 13th harmonics so as significantly reduce average voltage harmonics, compared to single tuned filter that only reduce 5th harmonics.

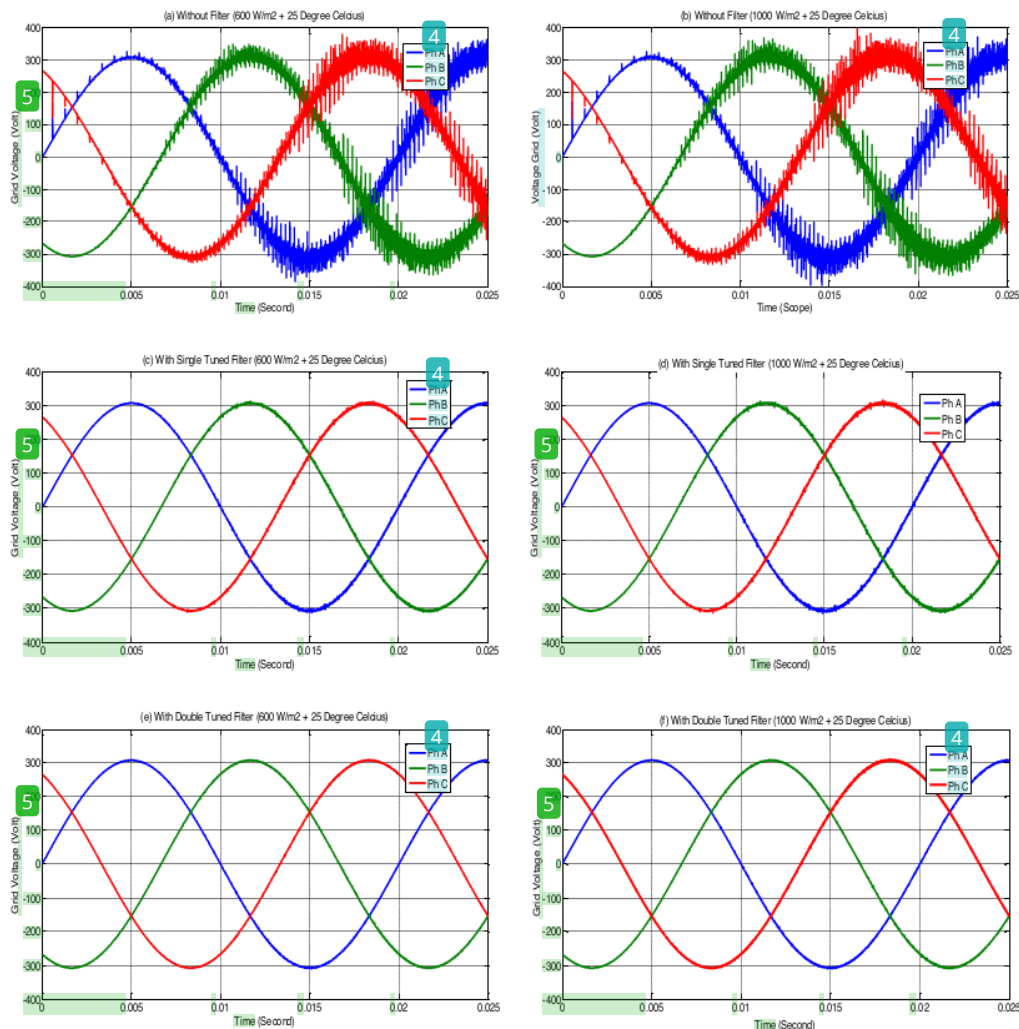

Figure 5. Voltage waveform at two levels of solar irradiance with temperature of 25°C

(a) Without filter (irradiance 600 W/m²)(b) Without filter (irradiance 1000 W/m²)(c) With single tuned filter (irradiance 600 W/m²)(d) With single tuned filter (irradiance 1000 W/m²)(e) With double tuned filter (irradiance 600 W/m²)(f) With double tuned filter (irradiance 1000 W/m²)Figure 6. Voltage harmonics spectra on phase A at two levels of solar irradiance with temperature of 25⁰ C

Table 3 shows that maximum currents in phase A, B, and C, for system without filter for all irradiance levels (400 to 1000 W/m²) and temperatures (20 to 40⁰C) are different e.i. 12.5, 9.8, and 10 A respectively, resulting in an unbalanced current of 16.10%. In the same condition, single tuned filter is able to balance phase currents of 10.45 ampere each, resulting in an unbalanced current equal to 0%. Under without filter conditions, irradiance remains, and temperature increases (20⁰C to 40⁰C), average current harmonics (THD_i) is relatively same. While the conditions without filter and temperature remains, but irradiance increases, then average current harmonics also increases. The lowest average current harmonics generated at irradiance of 400 W/m² and temperature of 300C as 1.653%, while the highest occurs at irradiance of 1000 W/m² and temperature of 20⁰C as 1.957%. Under condition of with single tuned filter, fixed irradiance, and temperature increases, then average current harmonics is relatively same. Under same filter condition and fixed temperature, but irradiance increases, so average current harmonics value also increases. The lowest average current harmonics is generated at 400 W/m² irradiance and temperature (20⁰C to 40⁰C) as 0.09%, while the highest happens at irradiance of 800 W/m² and temperature (20⁰C to 35⁰C) as 0.17%. The application of double tuned filter at fixed irradiation and temperature increase produces a relatively constant current harmonics. Otherwise, on fixed temperature and irradiance increases, then average current harmonics also increases. The lowest average current harmonics is generated at irradiation of 400 W/m² and temperature (20⁰C to 40⁰C) as 0.03%, while the highest harmonics happen at irradiance of 800 W/m² and temperature

(20⁰C to 40⁰C) as 0.05%. Implementation of double tuned filter on three phase PV generator can decrease average current harmonics better than single tuned filters.

Figure 7(a) shows that at increasing irradiance level (400 W/m² to 1000 W/m²) and fixed temperature (25⁰ C), average voltage harmonics also increases. Double tuned filter can significantly reduce average voltage harmonics of system compared to single tuned filter and without filter. Figure 7(b) also shows that at increasing irradiance level (400 W/m² to 1000 W/m²) and fixed temperature (25⁰ C), average current harmonics also increases. Double tuned filter is mostly effective to suppress 11th and 13th harmonics so it can mitigate both average voltage harmonics and average current harmonics, better than system with single tuned filter which can only decrease 5th harmonics.

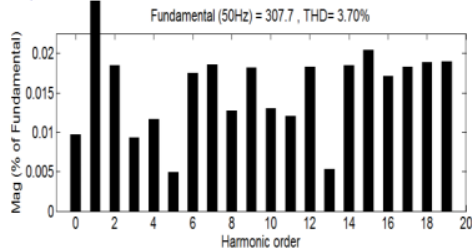
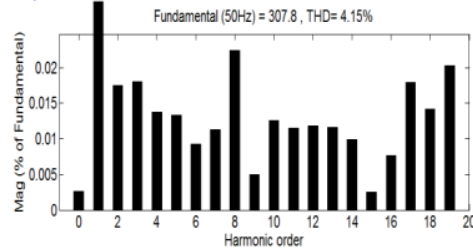
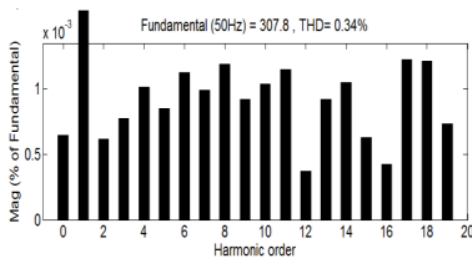
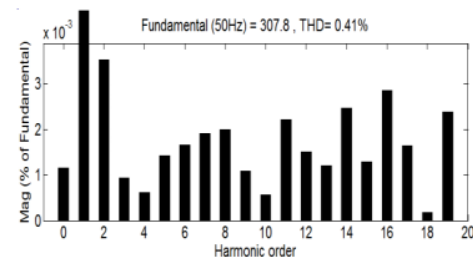
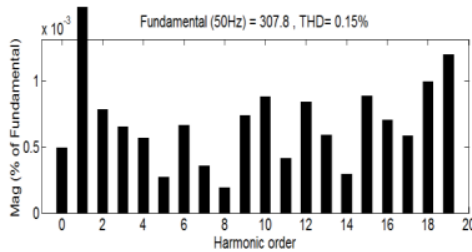
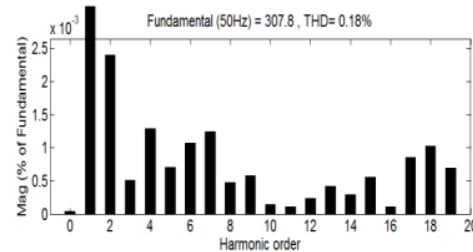
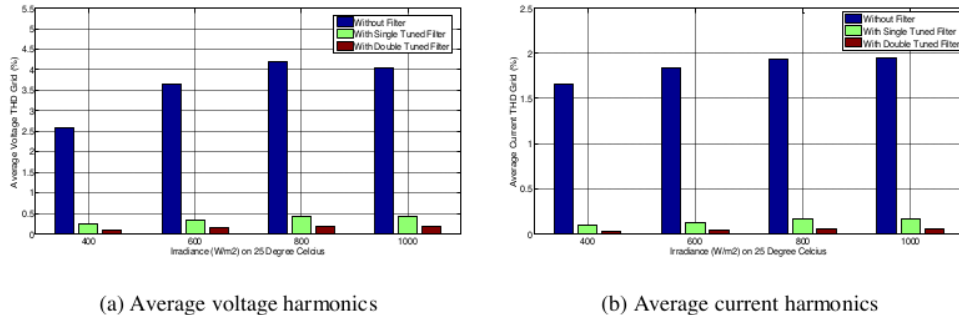

Figure 7. Performance of average harmonics at four irradiance levels (temperature 25⁰C)

4. CONCLUSION

Multi units of PV generator connected to a three phase distribution network, without filter, with single tuned, and with double tuned filter at all temperatures and irradiance levels results in relatively stable phase voltage (308 volt and 310 volt), so able to generate an unbalanced voltage of 0%. The maximum phase current for the system without filter at all temperatures and radiation levels of 12.5, 9.8, and 10 A, respectively, resulting in an unbalanced current of 16.10%. Under the same condition, single tuned and double tuned filters are able to balance phase current to 10.45 A and 10.44 ampere respectively, resulting in an unbalanced current of 0%. Implementation of single tuned and double tuned filters able to reduce unbalance current according to ANSI/IEEE 241-1990. At constant temperature and irradiance increases, both average voltage and current harmonics also increase. Double tuned active filter is the most effective to suppress the 11th and 13th harmonics so capable to mitigate average voltage and current harmonics better than system using single tuned filter which can only reduce 5th harmonic within IEEE 519-1992.

ACKNOWLEDGEMENTS

The authors would like to acknowledge to Directorate of Research and Community Service, Ministry of Research, Technology, and Higher Education, Republic of Indonesia, for financial support through Beginner Lecturer Research base on Contract Number 010/SP2H/K2/KM/2017 date on 4 May 2017.

REFERENCES

- [1] Kow Ken Weng et.al., "Power Quality Analysis for PV Grid Connected System Using PSCAD/EMTDC", *International Journal of Renewable Energy Research*, Vol.5, No.1, 2015, Turkey.
- [2] Minas Patsalides et.al., "The Effect of Solar Irradiance on the Power Quality Behaviour of Grid Connected Photovoltaic Systems", Department of Electrical and Computer Engineering, University of Cyprus, Electricity Authority of Cyprus, Institut für Physikalische Elektronik Pfaffenwaldring, Stuttgart, Germany.
- [3] Renu V et.al., "Optimal Control of Selective Harmonic Elimination in a Grid-Connected Single-Phase PV Inverter", *International Conference on Advances in Green Energy*, Dec 2014, Trivandrum, India, pp. 17-18.
- [4] Masoud Farhoodnea, et.al., "Power Quality Analysis of Grid-Connected Photovoltaic Systems in Distribution Networks", University Kebangsaan Malaysia (UKM), PRZEGLĄD ELEKTROTECHNICZNY, 2013.

- [5] K.P. Kontogiannis, et.al., "Power Quality Field Measurements on PV Inverters", *International Journal of Advanced Research in Electrical, Electronics and Instrumentation Engineering*, Vol. 2, Issue 11, November 2013, pp. 5301-5314.
- [6] Almas Hossain Mollah, et.al., "Three Phase Grid Connected Photovoltaic System with Maximum Power Point Tracking", *International Journal of Advanced Research in Electrical, Electronics and Instrumentation Engineering*, Vol. 4, Issue 5, May 2015, pp. 4637-4647.
- [7] Amirullah, et.al., "Power Quality Analysis of Integration Photovoltaic Generator to Three Phase Grid under Variable Solar Irradiance Level", *TELKOMNIKA (Telecommunication Computing Electronics and Control)*, Vol. 14, No. 1, March 2016, pp. 29-38.
- [8] Rachid Belaidi, et.al., "A Three-Phase Grid-Connected PV System Based on SAPF for Power Quality Improvement", *TELKOMNIKA (Telecommunication Computing Electronics and Control)*, Vol.15, No.3, September 2017, pp. 1003~1011.
- [9] Amirullah, et.al., "Multi Units of Single Phase Distributed Generation Combined With Battery Energy Storage for Phase Balancing in Distribution Network", *Jurnal Teknologi (Science and Engineering)*, Universiti Teknologi Malaysia (UTM) Publisher, Volume 78: 10-4 (2016), pp. 27-33.
- [10] Ali Reza Reisi, et.al., "Combined Photovoltaic and Unified Power Quality Controller to Improve Power Quality", *Solar Energy* Vol. 88, Februari 2013, pp.154-162.
- [11] Amirullah, et.al., "Power Quality Enhancement of Integration Photovoltaic Generator to Grid under Variable Solar Irradiance Level using MPPT-Fuzzy", *International Journal of Electrical and Computer Engineering*, Vol. 6, No. 3 December 2016, pp. 2629-2642.
- [12] Bilal, Jos and Watson, Neville, "Power System Harmonics", *Chicester: John Wiley and Sons*, 2003.
- [13] Thomas M. Bloming, P.E. and Daniel J. Carnovale, P.E., "Application of IEEE Standar 519-1992 Harmonic Limits", Presented at The 2005 IEEE IAS Pulp and Paper Industry Conference in Appleton, WI.
- [14] ANSI/IEEE 241, "IEEE Recommended Practice for Electric Power Systems in Commercial Buildings", 1990.
- [15] Amirullah, et. al., "Effect of Installation of Photovoltaic (PV) Generation to Power Quality in Industrial and Residential Customers Distribution Network", International Seminar Intelligent Technology and Its Application ITS Surabaya, ISBN: 978-1-4799-7710-9, Surabaya, May 20th -21st, 2015, pp.191-198.
- [16] Implement Four Types of Three-Phase Harmonic Filters using RLC Components, Available Online: <https://www.mathworks.com/help/physmod/sps/powersys/ref/threephaseharmonicfilter.html>, accessed date on 5 September 2017.

BIOGRAPHIES OF AUTHORS



Adiananda was born in Nganjuk East Java Indonesia, in 1973. He received bachelor and master degree in electrical engineering from University of Bhayangkara Surabaya and master of computer science from Gadjah Mada University (UGM) Yogyakarta, in 1996 and 2016, respectively. Since 1998, He had worked as a lecturer in University of Bhayangkara Surabaya. He is interested in research of application of artificial intelligent in modelling power electronics and computer system.



Agus Kiswanton was born in Malang East Java Indonesia, in 1971. He received bachelor and master degree in electrical engineering from Institut Teknologi Adhi Tama Surabaya (ITATS) and ITS Surabaya, in 1995 and 2009, respectively. He also worked as a lecturer in University of Bhayangkara Surabaya. His research interest includes power system modeling and simulation, application of artificial intelligent in power system and power distribution, as well as renewable energy in distributed generation.



Amirullah was born in Sampang East Java Indonesia, in 1977. He received bachelor and master degree in electrical engineering from University of Brawijaya Malang and ITS Surabaya, in 2000 and 2008, respectively. He also worked as a lecturer in University of Bhayangkara Surabaya. He is currently working toward the doctoral degree, in electrical engineering in Power System and Simulation Laboratory (PSSL) ITS Surabaya. His research interest includes power system modeling and simulation, power quality, harmonics distortion, design of harmonics filter/power factor correction, and renewable energy.

Multi Units of Three Phase Photovoltaic using Band Pass Filter to Enhance Power Quality in Distribution Network under Variable Temperature and Solar Irradiance Level

ORIGINALITY REPORT

13%

SIMILARITY INDEX

PRIMARY SOURCES

- 1 jurnal.untan.ac.id 182 words — 2%
Internet
- 2 Mouna Tali, Abdellatif Obbadi, Abdelkrim Elfajri, Youssef Errami. "Passive filter for harmonics mitigation in standalone PV system for non linear load", 2014 International Renewable and Sustainable Energy Conference (IRSEC), 2014 101 words — 1%
Crossref
- 3 www.scribd.com 82 words — 1%
Internet
- 4 Amirullah, Adi Soeprijanto, Adiananda, Ontoseno Penangsang. "Power Transfer Analysis Using UPQC-PV System Under Sag and Interruption With Variable Irradiance", 2020 International Conference on Smart Technology and Applications (ICoSTA), 2020 72 words — 1%
Crossref
- 5 data.obitet.net 70 words — 1%
Internet
- 6 K. S. Raja Sekhar, M. A. Chaudhari. "Reactive Power Enhancement of a PLL less PV inverter for AC Micro-

7	telkomnika.uad.ac.id Internet	62 words — 1%
8	Aouatif Ibnelouad, Abdeljalil El Kari, Hassan Ayad, Mostafa Mjahed. "A comprehensive comparison of the classic and intelligent behavior MPPT techniques for PV systems", 2017 14th International Multi-Conference on Systems, Signals & Devices (SSD), 2017 Crossref	42 words — 1%
9	Arrillaga. "Subject Definition and Objectives", Power System Harmonics, 09/26/2003 Crossref	32 words — < 1%
10	Arman, Mahmoud Fayez(Darwish, MK). "An 'active' passive-filter topology for low power DC/AC inverters", Brunel University School of Engineering and Design PhD Theses, 2011. Publications	27 words — < 1%
11	indonesianjpharm.farmasi.ugm.ac.id Internet	25 words — < 1%
12	www.engbookspdf.com Internet	24 words — < 1%
13	www.mdpi.com Internet	24 words — < 1%
14	www.textroad.com Internet	19 words — < 1%
15	ethesis.nitrkl.ac.in Internet	16 words — < 1%

-
- 16 M.M. Rahman, M. Hasanuzzaman, N.A. Rahim. "Effects of various parameters on PV-module power and efficiency", Energy Conversion and Management, 2015
Crossref 15 words — < 1%
-
- 17 Eko Prasetyo, Nanik Suciati, Chastine Fatichah. "Yolov4-tiny with wing convolution layer for detecting fish body part", Computers and Electronics in Agriculture, 2022
Crossref 14 words — < 1%
-
- 18 Md. Rashidul Islam, Md. Mehedi Hasan, Faisal R. Badal, Sajal K. Das, Subarto Kumar Ghosh. "A Blended Improved H5 Topology with ILQG Controller to Augment the Performance of Microgrid System for Grid-Connected Operations", IEEE Access, 2020
Crossref 12 words — < 1%
-
- 19 events.saip.org.za
Internet 12 words — < 1%
-
- 20 thesai.org
Internet 12 words — < 1%
-
- 21 www.svec.education
Internet 12 words — < 1%
-
- 22 media.neliti.com
Internet 11 words — < 1%
-
- 23 Ayse Kocalmis Bilhan, Abuzer Caliskan, Sencer Unal. "Simulation of a photovoltaic panels by using Matlab/Simulink", 2016 8th International Conference on Electronics, Computers and Artificial Intelligence (ECAI), 2016
Crossref 9 words — < 1%
-

- 24 H.-G. Eckel. "Sondergebiete der Leistungselektronik", Leistungselektronische Schaltungen, 2008
Crossref 9 words — < 1%
-
- 25 Kichou, Sofiane, Santiago Silvestre, Letizia Guglielminotti, Llanos Mora-López, and Emilio Muñoz-Cerón. "Comparison of two PV array models for the simulation of PV systems using five different algorithms for the parameters identification", Renewable Energy, 2016.
Crossref 9 words — < 1%
-
- 26 docshare.tips
Internet 9 words — < 1%
-
- 27 www.hindawi.com
Internet 9 words — < 1%
-
- 28 Nguyen Gia Minh Thao, Kenko Uchida, Kentaro Kofuji, Toru Jintsugawa, Chikashi Nakazawa. "An Automatic-Tuning Scheme Based on Fuzzy Logic for Active Power Filter in Wind Farms", IEEE Transactions on Control Systems Technology, 2019
Crossref 8 words — < 1%
-
- 29 Yujian Gong, Zuo Wang, Zeyu Lai, Minlin Jiang. "TVACPSO-assisted analysis of the effects of temperature and irradiance on the PV module performances", Energy, 2021
Crossref 7 words — < 1%
-
- 30 L. Wentao, X. Qunwei, X. Haiwei, S. Chen, C. Feng. "Research on Parameters Equivalent Transformation Method for AC Filters in HVDC Transmission System", The 16th IET International Conference on AC and DC Power Transmission (ACDC 2020), 2021
Crossref 6 words — < 1%

31

Y.J. Dai, K. Sumathy, R.Z. Wang, Y.G. Li.
"Enhancement of natural ventilation in a solar
house with a solar chimney and a solid adsorption cooling
cavity", Solar Energy, 2003

6 words — < 1%

Crossref

EXCLUDE QUOTES OFF

EXCLUDE BIBLIOGRAPHY OFF

EXCLUDE SOURCES OFF

EXCLUDE MATCHES OFF