

ADVANCED CONTROL OF ACTIVE RECTIFIER USING SWITCH FUNCTION AND FUZZY LOGIC FOR NONLINEAR BEHAVIOUR COMPENSATION

^{1,2}SAIDAH, ¹M. HERY PURNOMO, ¹M. ASHARI

¹Department of Electrical Engineering
Sepuluh Nopember Institute of Technology (ITS), Surabaya-Indonesia

²Department of Electrical Engineering
Bhayangkara University, Surabaya-Indonesia

E-mail: ¹sdhbaisa61@yahoo.com, ²hery@ee.its.ac.id, ³ashari@ee.its.ac.id

ABSTRACT

Power Semiconductor switches of active rectifier are characterized by highly nonlinear property, resulting in high harmonic distortion and high ripple voltage on the DC side. This paper presents advanced control using switch function and fuzzy logic for compensating nonlinear behaviour. The system applies switch function of time as the input of control strategy, instead of current and voltage in d-q frame. The fuzzy logic controller aims to minimize DC voltage deviation by regulating the line current amplitude. This system uses minimum number of sensors, which is the voltage only to avoid the effect of sensor nonlinearity to the system. This performance is demonstrated and compared with PI-optimized controller. Simulations result have been conducted for variation values of capacitance, inductance and loads. The results show that the harmonic distortion and the ripple voltage on the DC side are 0.036 % compared PI-optimized controller as 5.64 %.

Keywords: *Fuzzy Logic Controller, PI-optimized, Harmonic Distortion, Optimized Controller*

1. INTRODUCTION

Active Rectifier is widely used in industrial applications because it has many advantages including unity power factor, low ripple of the DC-voltage and low total harmonics distortion. Due to these features, the active rectifier is a good choice for application in industrial drives [1-2].

At first, PID controllers were considered as simple and robust techniques [6, 9-10]. However, one of the drawbacks in using PID control techniques was that they were not sufficient to obtain the desired tracking control performance because of the nonlinearity of the rectifier. Then, the method known as fuzzy logic control was introduced. This method is able to overcome the nonlinear systems. There are publications presenting the miscellaneous results of the Fuzzy Logic in application to the control systems of the switched-mode rectifier. The first design of the fuzzy Logic control system was created to overcome nonlinear impedance on the DC side, particularly when the characteristics of the DC side

generation/load are unknown [12]. Later, the system with two fuzzy logics is used to control the current feedforward and modulation, then, it is analyzed to look for high performance even by using small passive elements and low switching frequency [13]. Other publication uses Fuzzy Logic controller to optimize the capacitor charge/discharge process in a PWM rectifier. This results in a regulated output voltage and power factor, even during various kinds of perturbations [14].

This paper proposed the fuzzy logic controller to overcome the nonlinearity of three-phase active rectifier. The principle of this Fuzzy Logic was to minimize the voltage deviation from its reference and to regulate variation of line current amplitude. To control current amplitude, this system did not use any current sensor. This is to avoid the effect of sensor nonlinearity to the system. Hence, a fully regulated DC voltage was obtained with a low harmonic distortion of the line current. Then the control of the switching pattern and their duty cycle space vector modulation (SVM) with switch function as input was used.

2. PROPOSED CONTROL STRATEGY

In general, control strategy for switching patterns and their duty cycles on the rectifier uses voltage or current. This system proposed the use of switching function in d–q frame (s_d , s_q) obtained from the calculation from the model transformation. Switching function in d–q frame was converted into $\alpha \beta$ frame (s_α , s_β) and then it was used as the input of SVM (Space Vector Modulation) to get gate signals, as shown in Fig. 1. The proposed system also developed a fuzzy logic to control the amplitude of the line current based on the deviation of the DC voltage

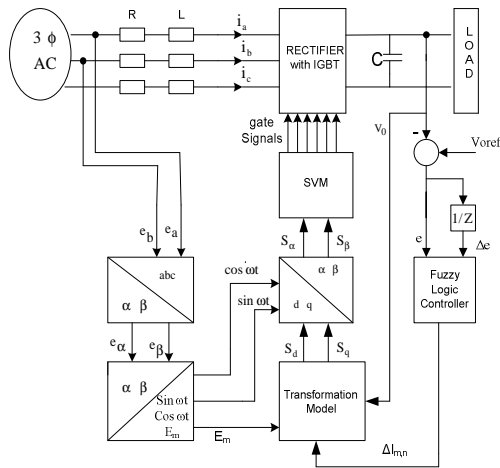

Fig. 1. Block diagram of the proposed control strategy

3. THE MODELLING AND DESIGN OF THE THREE-PHASE ACTIVE RECTIFIER

3.1 Mathematical Model

Figure 2. represents the topology of the three-phase active rectifier proposed. The dynamic model of rectifier consists of a three-phase network connected to three-phase supply voltage e_a , e_b , e_c by assuming a balanced three-phase system, the three-phase input line currents i_a , i_b , i_c and v_a , v_b , v_c which represent the three-phase voltages generated by the PWM active rectifier. R and L are the resistance and inductance of the line, a smoothing capacitor, and the load represented by a current source.

The mathematical model of the three-phase system written in space vectors was as follows[15]:

$$x(t) = 2/3 [x_a(t) + a x_b(t) + a^2 x_c(t)] \quad (1)$$

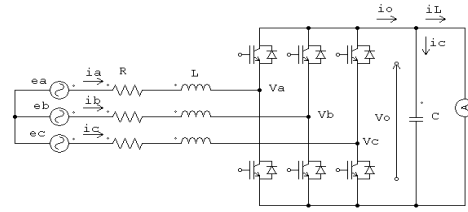

Figure 2. Three-Phase Active Rectifier System

Where $a=e^{j2\pi/3}$ and $x_a(t)$, $x_b(t)$ dan $x_c(t)$ were the components of the three-phase system.

Then the mathematical model of the active rectifier was analyzed using space vector:

$$\begin{aligned} v(t) &= e(t) - Ri(t) - L di(t)/dt \\ v(t) &= 1/2 s(t)v_o(t) \\ i_o(t) &= (3/4) \text{Re}\{s(t)i^+(t)\} \\ i_c(t) &= C dv_o/dt = i_o(t) - i_L(t) \end{aligned} \quad (2)$$

Where

- $v(t)$ = rectifier input voltages
- $i(t)$ = rectifier input currents
- $i^+(t)$ = complex conjugate of $i(t)$
- $e(t)$ = the input line voltages
- $i_o(t)$ = rectifier output current
- $i_c(t)$ = capacitor current
- $i_L(t)$ = load current
- $s(t)$ = switching function
- $v_o(t)$ = output voltage

The mathematical model written in state space form was

$$dv_o(t)/dt = 1/C \{3/4 \text{Re}\{s(t)i^+(t)\} - i_L(t)\} \quad (3)$$

$$di(t)/dt = 1/L [-Ri(t) + e(t) - 1/2 s(t)v_o(t)] \quad (4)$$

When the drop voltage across R was neglected, the equation (4) was

$$di(t)/dt = 1/L [e(t) - 1/2 s(t)v_o(t)] \quad (5)$$

The equation in (3),(5) showed that the system was nonlinear second order and its behaviour depended on the vector $s(t)$.

From (5), switching function $s(t)$ could be obtained as

$$S(t) = 2/v_o(t) [e(t) - L di(t)/dt] \quad (6)$$

3.2 Design Current Controller For The Three-Phase Rectifier

The controller design of the line current had two purposes: the first was to obtain line current with low harmonic distortion and unity power factor; the second was to obtain controlled the dc voltage.

Thus, the system overall performance of the system depended on the design of the current control.

3.2.1 Current Sensorless

The sensor had an important role in determining overall system performance because dynamic and static characteristics of the sensor gave the true value of the output variable that would be measured. So, using minimum number of sensors will reduce the effect of noise and complexity of the system. This system eliminated the use of two pieces of current sensor so-called current sensorless. The system used three of the voltage sensors (two AC voltage and one of DC voltage sensors).

The system sensorless work based on the Transformation Model, as shown in Fig. 1. Equation 10 – 15 shows steps to obtain the switch function s_d and s_q in discrete model

$$\begin{aligned} e_n &= E_m \exp(j\omega t_n) \\ i_n &= I_{m,n} \exp(j\omega t_n) \\ s_n &= S_{m,n} \exp[j(\omega t_n + \phi_n)] \end{aligned} \quad (10)$$

Where $t_n = nT_s$ and $t_{n-1} = (n-1)T_s$ were the discrete-time variables and T_s was the sampling period.

The switching vector s_n was obtained from calculating variation of the current amplitude, $\Delta I_{m,n}$ was output of Fuzzy Logic Controller.

Equation (6) was written in discrete as

$$\begin{aligned} s_{n,d} &= \frac{2}{v_{g,n}} \left\{ e_n - L \frac{di(t)}{dt} \right\} \\ s_{n,q} &= \frac{2}{v_{g,n}} \left\{ e_n - L \frac{i_n - i_{n-1}}{t_n - t_{n-1}} \right\} \\ s_n &= \frac{2}{v_{g,n}} \left\{ e_n - L \frac{I_{m,n} \exp(j\omega t_n) - I_{m,n-1} \exp(j\omega t_{n-1})}{t_n - t_{n-1}} \right\} \\ s_n &= \frac{2}{v_{g,n}} \left\{ e_n - L \frac{[I_{m,n} - I_{m,n-1} \exp(-j\omega T_s)] \exp(j\omega t_n)}{T_s} \right\} \end{aligned} \quad (11)$$

From (11) switching vector in d-q frame rotating at angular speed ω was obtained

$$s_{n,d} = \frac{2}{v_{g,n}} \left\{ E_m - \frac{L}{T_s} [I_{m,n} - I_{m,n-1} \cos(\omega T_s)] \right\} \quad (12)$$

$$s_{n,q} = -\frac{2}{v_{g,n}} \left[\frac{L}{T_s} I_{m,n-1} \sin(\omega T_s) \right] \quad (13)$$

Where $\omega_s = (2\pi/T_s) \gg \omega$ and $\omega T_s = (2\pi\omega/\omega_s) \rightarrow 0$, equation (12) and (13) become

$$s_{n,d} \cong \frac{2}{v_{g,n}} \left\{ E_m - \frac{L}{T_s} \Delta I_{m,n} \right\} \quad (14)$$

$$s_{n,q} \cong \frac{2}{v_{g,n}} [-\omega L I_{m,n-1}] \quad (15)$$

Equation (14) and (15) are the final formula for s_d and s_q , which are used in Transformation Model block in Fig. 1. It was clear that vector switching s_d dan s_q only depended on $\Delta I_{m,n}$ and current reference was not needed [13].

3.2.2 Fuzzy Logic Controller Design

Fuzzy Logic Controller approach offers the possibility to model a nonlinear system on the basis of the knowledge of many not-well defined relations among the systems and to design a controller that adapts itself to several working conditions.

A Fuzzy Logic Controller is based on a collection of control rules governed by the compositional rule of inference. A fuzzy system realises a nonlinear correspondence between a vectorial input and a scalar output [7]-[8].

In this system, fuzzy logic controller was aimed to minimize the error (e) by regulating the amplitude of $\Delta I_{m,n}$. The Input of fuzzy Logic Controller includes voltage variation from the reference (e) and the deviation (Δe), while the output was the variation of the current amplitude $\Delta I_{m,n}$. The membership functions for input and output variables are reported in Fig. 3, Fig. 4 and Fig. 5.

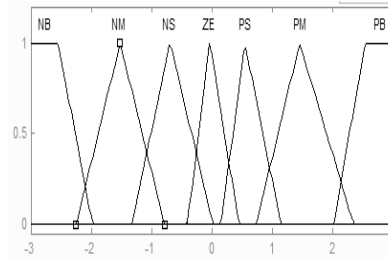

Fig. 3. The membership function of output voltage variation

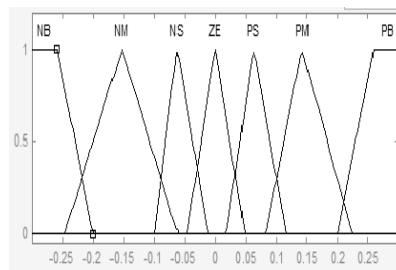

Fig. 4. The membership function of output voltage variation

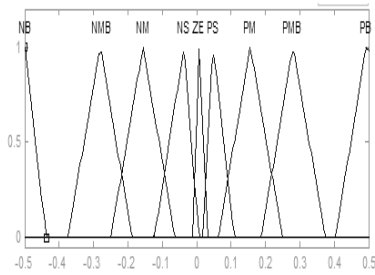

Fig. 5. The membership function of variation current amplitude

3.3 Space Vectors of Modulation

The component d and q of the switching vector (13) were transformed into the α and β components of stationary frame and they were used as inputs for space vector modulation (SVM). Space vector algorithm can be depicted in the flowchart as shown in Fig. 6. This algorithm describes the process to obtain the control signal switches of the three-phase rectifier through a switch reference vectors.

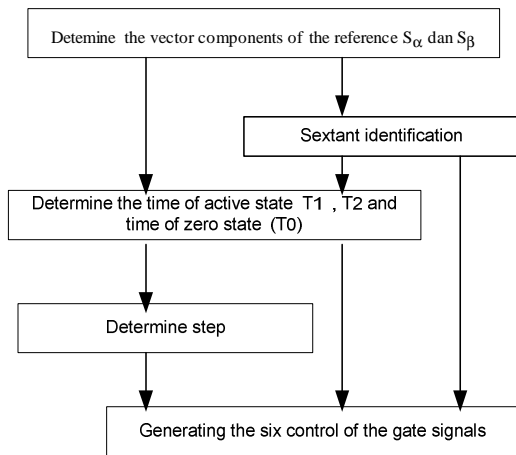

Fig 6. Algorithm of Space Vector Modulation

3.4 PI Optimized

The design of PI Optimized was aimed to tune the gains of the PI controller (K_p and K_i) and to optimize the response of the plant. The following are steps for PI optimized,

1. apply constraint block placed at actuator signal and output signal. The constraint block showed the plant response for each iteration of the optimized process and the black curve represented the optimized response.
2. Run the simulation producing an unoptimized response and the initial data for optimization.

3. Perform the scope block to view the unoptimized response.
4. The output of constraint block to view constraints on the plant response, including rise time, settling time and maximum overshoot.
5. In the block parameters window, click the start optimization button to begin optimization. The model also included the actuator constraint block, but you could start optimization from any constraint block. The actuator constraint block defined the constraints on the actuation signal of the controller.

The result simulation by using PI-optimized showed that proportional constant (K_p) was 3.18 and integral constant (K_i) was 5.024.

4. RESULT AND DISCUSSION

The proposed controller was evaluated through several simulations. This section present the most relevant results. The controller performance was tested through simulations on a system which data were: nominal load power $S_N = 7$ kW, parameters $E_m = \sqrt{2} \cdot 220$ volt, $V_{dc} = 650$ volt, $\omega = 2\pi \times 50$ rad/s, $R = 0.3 \Omega$, $L = 8$ mH, $C = 1000 \mu F$.

Simulation results using the fuzzy logic controller were compared to simulation using a PI optimized. The purpose of this comparison was to obtain good performance of the rectifier system due to nonlinear effects.

Fig.7. Presents the DC-link voltage with PI Optimized and fuzzy logic. The fuzzy controller reduced dc-link voltage ripple 0.036 % with respect to PI optimized control method with ripple 5.64 %. Fig.8. Demonstrates the line phase voltage and current. The simulation results showed that THD = 3.956 % and Power factor = 0.9921.

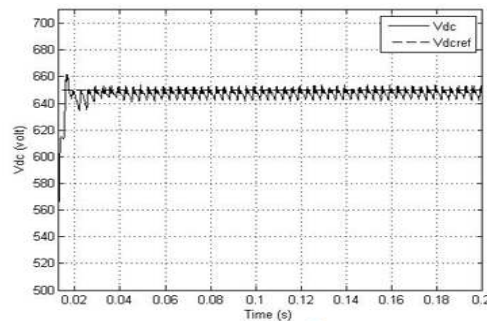

Fig.7. (a). Presents the DC-link voltage with PI Optimized

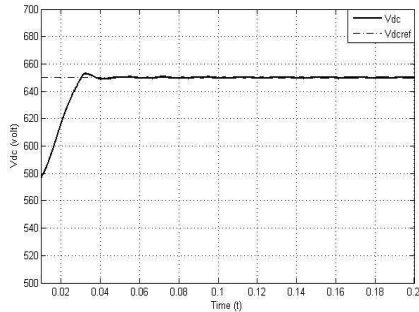

Fig. 7(b) with fuzzy logic

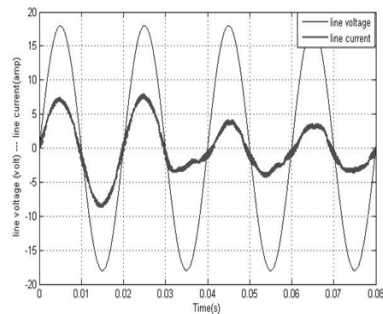

Fig.8. demonstrates the grid phase voltage and line phasa current

Fig. 9a demonstrates the three-phase line current under the step change of the rectifier load and Fig. 9b present the rapid transient of the DC link voltage.

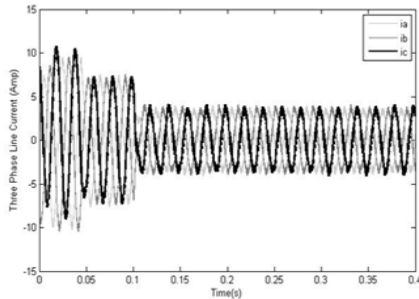

Fig. 9 (a)

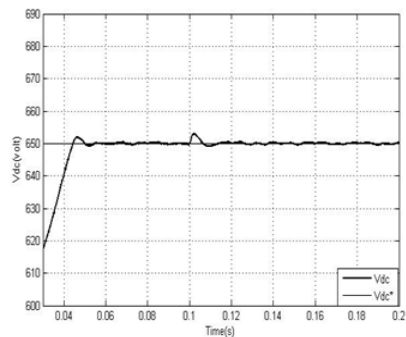

Fig. 9 (b)

Fig. 9. (a) three phase line current and (b) the rapid transient of the DC-link voltage

In this simulation, we observed the rectifier's behavior by varying the values of the inductor and the capacitor. Fig. 10 demonstrates the robustness of DC voltage of the rectifier using Fuzzy controller under various values of capacitance and inductance. The system performance was not much affected by the change.

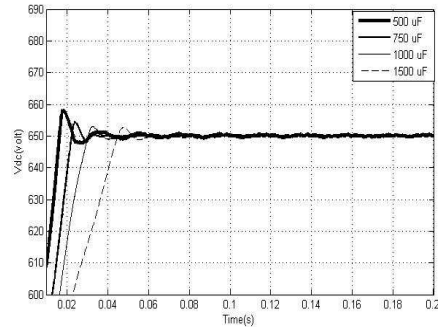

Fig. 10 (a)

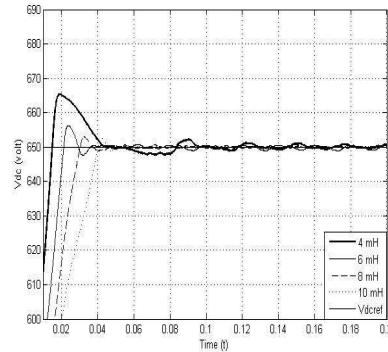

Fig. 10 (b)

Fig. 10. (a). Demonstrates the robustness DC voltage of the rectifier's Fuzzy control system to the DC link capacitance changes and (b). inductance changes.

5. CONCLUSION

This paper presented advanced control of active rectifier using switch function and fuzzy logic for nonlinear behaviour compensation. Two different controller structure, fuzzy logic and PI optimized controllers, were also presented to compare the system performances. Simulation results showed that the fuzzy controller had better characteristics compared to PI-optimized control methods, in dealing with the nonlinearity behaviour.

**REFERENCES:**

- [1] Hong-Seok Song, In-Won Joo, and Kwanghee Nam, "Source Voltage Sensorless Estimation Scheme for PWM Rectifiers Under Unbalanced Conditions", IEEE Transactions On Industrial Electronics, VOL. 50, NO. 6, December 2003.
- [2] Ashari, M., W.W.L. Keerthipala and C.V. Nayar, "A Single Phase Parallely Connected Uninterruptible Power Supply/ Demand Side Management System", IEEE Transactions on Energy Conversion, vol. 15, No. 1, March 2000, pp.97-102.
- [3] Carlos Gaviria, Enric Fossas, and Robert Griñó, "Robust Controller for a Full-Bridge Rectifier Using the IDA Approach and GSSA Modeling", IEEE Transactions On Circuits And Systems—I: Regular Papers, Vol. 52, No. 3, March 2005
- [4] N.Albert Singh, M.Marsaline Beno, "An Intelligent controller for a non-linear Power Electronic Boost converter", IEE Proc.of Int. Conf. on Energy, Information Technology and Power Sector,Kolkata, pp.232-235, 2005.
- [5] Joseph Jawhar. S, Dr. N.S. Marimuthu, Albert Singh. N, "An Neuro-Fuzzy Controller for a Non Linear Power Electronic Boost Converter", 2006 IEEE
- [6] R. S. Pens, R. J. Cardenas, J.C.Clare, G.M.Asher, "Control Strategies for Voltage Control of a Boost Type PWM Converter" , 2001 IEEE.
- [7] Y. Murai, T. Watanabe, and H. Iwasaki, "Waveform distortion and correction circuit for PWM inverters with switching lag-times," IEEE Trans. Ind. Appl., vol. IA-23, no. 5, pp. 881–886, Sep./Oct. 1987.
- [8] Dong-Choon Lee, and Dae-Sik Lim, "AC Voltage and Current Sensorless Control of Three-Phase PWM Rectifiers", IEEE Transactions On Power Electronics, Vol. 17, NO. 6, November 2002
- [9] Marian P. Kazmierkowski, and Luigi Malesani, "Current Control Techniques for Three-Phase Voltage-Source PWM Converters: A Survey", IEEE Transactions On Industrial Electronics, Vol. 45, No. 5, October 1998
- [10] Ahmed Z. Alassar, Iyad M. Abuhadrous, Hatem A. Elaydi, "Comparison between FLC and PID Controller for 5DOF Robot Arm", 2010 IEEE.
- [11] Masoud Hajihashemi, Ali Nazeran Motlagh, "Improved 3-phase PWM Boost Rectifiers in Unbalanced Network by Fuzzy Controller", The International Conference on Electrical Engineering 2009.
- [12] R. S. Pens, R. J. Cardenas, J.C.Clare, G.M.Asher, "Control Strategies for Voltage Control of a Boost Type PWM Converter", 2001 IEEE.
- [13] Carlo Cecati , Antonio Dell'Aquila, Marco Liserre, and Antonio Ometto," A Fuzzy-Logic-Based Controller for Active Rectifier", IEEE Transactions On Industry Applications, Vol. 39, No. 1, January /February 2003.
- [14] Antonio Dell' Aquila, M. Liserre, C. Cecati, and A. Ometto A, " Fuzzy Logic CC-PWM Three-phase AC-DC Converter", 2000 IEEE.
- [15] Matti Jussila, Mika Salo, Lauri Kähkönen, and Heikki Tuusa, "Vector Modulated Three-Phase Four-Quadrant Rectifier" – Application to a DC Motor Drive", The authors are with the Institute of Power Electronics, Department of Electrical Engineering, Tampere University of Technology.