

# Self-Tuning Fuzzy–Pi Controller in VoltsHz Induction Motor Control For Electrically Driven Ship Propeller

*By* Bambang Purwahyudi

## 6 Self-Tuning Fuzzy-Pi Controller in Volts/Hz Induction Motor Control For Electrically Driven Ship Propeller

Bambang Purwahyudi<sup>1</sup>, Saidah<sup>2</sup>, Hasti Afianti<sup>3</sup>

Department of Electrical Engineering, University of Bhayangkara Surabaya,  
INDONESIA.

<sup>1</sup> [bmb\\_pur@yahoo.com](mailto:bmb_pur@yahoo.com)

### ABSTRACT

2 The induction motors are widely used in industrial applications, especially in electric propulsion system. Induction motor is required to rotate the propeller for producing ship propulsion. The volt/Hz (V/f) control based induction motor (IM) using conventional PI controller with fixed parameters cannot provide desired control performance under load disturbance and transient conditions. In this paper, Fuzzy-PI control 19 is proposed and presented to improve the dynamic performance of the IM drive. Fuzzy logic (FL) is used to adjust the parameters of PI controller according to various systems operating condition. The effectiveness of the proposed systems is verified by simulation process. Therefore, the Fuzzy-PI controller has better performance compared to the conventional PI controller during change of operating condition. Simulation results of Fuzzy-PI controller show that the induction motor rapidly reaches the speed reference, has small steady state error and overshoot. And also reduce speed oscillation during load disturbance condition.

**Keywords:** Induction motor, Volts/Hz Control, Self tuning fuzzy-PI controller, Electric Propulsion System

### INTRODUCTION

With the development of power system around the world, electrical energy is applied to many marine 2 transportation systems particularly in electric propulsion system. In this system, electric motor is required to drive the marine propeller to produce the ship propulsion. The electric motor can be directly connected with the ship propeller. The control of electric motor is very complex and totally difference compared with in industries. This control is affected by ocean surface waves, ocean current, wind, weather and also ship motions such as yaw, pitch and rolls (Faiz et al., 1999; Adnanes, A. K., 2003; He-ping, H., 2007). The most popular electric motors is induction motor because it is having well known advantages like simple in construction, reliability, ruggedness and free maintenance. However, induction motor is difficult to control a constant speed whenever the load is changed. Many methods have been proposed by many researchers to solve such kind of problem. One of the popular methods to solve the problem is volts/Hz (V/f) method. This method maintains a constant ratio of voltage and frequency to produce the optimum speed and torque of induction motor. The voltage and frequency is directly controlled by voltage source inverter (Ioannides et al., 2003; Oros et al., 2006; Nuno et al, 2006; Khan, M., 2007; Win et al., 2008; Kohlrusz et al., 2011).

2 The speed control of induction motor drive employ speed controller. The PI controller is most widely used for the speed controller. However, PI controller cannot provide the satisfactory control performance during change of operating condition. Many researchers have been proposed many strategy controls to solve the drawback of the PI controller using artificial intelligence (AI) methods. These methods are very promising for the identification and control nonlinear dynamic system without acknowledge the internal system behaviors

(Zerikat al, 2005; Nour et al, 2008; Gadoue et al, 2009; Purwahyudi et al, 2011; Purwahyudi, B. et al, 2013).

This paper presents the usage of AI methods especially fuzzy logic (FL) to adjust the parameters of PI controller in the speed control of induction motor. The effectiveness of the proposed systems is verified by simulation process. The induction motor is employed in electric propulsion system because its complexity for the speed and torque. In this system, load torque of induction motor is torque produced by propeller, whereas propeller torque depends on the speed of induction motor and pitch angle of the propeller. Therefore, the Fuzzy-PI controller is compared with the conventional PI controller during change of operating condition based on the performance of induction motor.

### CONSTANT V/f CONTROL OF INDUCTION MOTOR

Constant V/f control of induction motor is based on voltage and frequency. Speed can be changed by increasing and decreasing frequency of input voltage. However, these variations obtain the change impedance. The change of impedance can cause increasing and decreasing current. If the current is small, torque of induction motor will decrease. If frequency is decreased or voltage is increased, the coils of induction motor can burn or saturation. This matter can be solved by changing frequency and voltage together. Value of stator voltage is formulated in Equation (1), where control of V/f constant produces stator flux constant (Win, T. et al, 2008; Kohlrusz, G. et al, 2011).

$$\frac{V}{f} = 4.44 N \psi_s k \dots\dots\dots (1)$$

Where,  $V$ ,  $f$ ,  $N$ ,  $\psi_s$ , and  $k$  are stator voltage, frequency, number of coils, stator flux and constant, respectively. Whereas, electromagnetic torque of induction motor as speed function is expressed in Equation (2).

$$T_m = \frac{3}{2\omega} I_r^2 \frac{R_r}{s} \dots\dots\dots (2)$$

Where,  $T_m$ ,  $\omega$ ,  $I_r$ ,  $R_r$ , and  $s$  are electromagnetic torque, angular speed, rotor resistance and slip, respectively.

Torque is inversely proportional to frequency and proportional to voltage is expressed in Equation (2). Speed and torque control can be solved by changing linear of two parameters shown in equation (3).

$$\frac{T}{f} = \frac{V^2}{2\pi f^2} \approx \frac{V}{f} \dots\dots\dots (3)$$

In constant V/f control, torque can be obtained at every the operation point until to rated speed point and also induction motor can be operated exceeding the nominal speed. When induction motor speed is above rated, torque will decrease inversely proportional to increasing frequency, because voltage input cannot exceed the operation voltage of electric motor drive.

V/f control method consists of a slip control loop, because slip is proportional to torque of induction motor. Rotor speed feedback signal ( $\omega_r$ ) from speed sensor is compared with speed reference ( $\omega_r^*$ ). Its comparison result is processed in a controller to produce slip ( $\omega_{sl}$ ), so that induction motor can achieve speed reference (Oros et al, 2006; Tunyasrirut et al., 2008;

Kohlrusz et al., 2011). Block diagram of  $V/f$  control with the Fuzzy-PI controller and marine propeller can be seen in Figure 1.

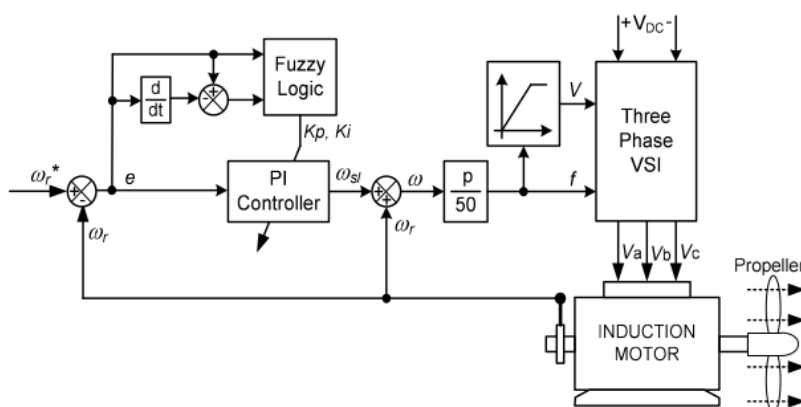

Figure 1. Block Diagram of  $V/f$  Control with Fuzzy-PI Controller

### DESIGN OF FUZZY-PI CONTROLLER

Fuzzy logic control is one of most popular fields where fuzzy theory can be successfully applied. Fuzzy logic techniques attempt to imitate human thought processes in technical or environmental. Fuzzy logic can also solve nonlinear control problems or whenever the system model is unknown or difficult to build. The fuzzy rules can be obtained through the knowledge of the process. The process knowledge is automatically extracted from sample process. The fuzzy logic control consists of three steps: fuzzification, control rules evaluation and defuzzification (Oros et al, 2006; Tunyasriut et al, 2008; Pham et al, 2012; Oleiwi et al, 2013). In this paper, a fuzzy logic (FL) is used to tune the parameters of PI controller ( $K_p$  and  $K_i$ ). Figure 2 shows the block diagram of self-tuning PI controller using fuzzy logic (FL).

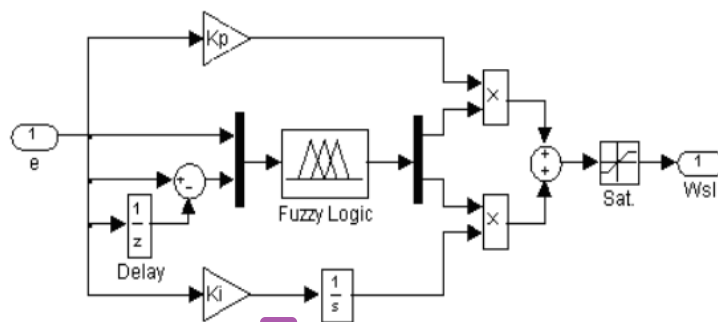

Figure 2. Block Diagram of Self tuning PI Controller Using Fuzzy Logic (FL)

Fuzzy logic has five membership functions (MF's) for two inputs and two outputs. Two inputs and two outputs are error ( $e$ ), change of error ( $de$ ), promotional parameter ( $K_p$ ), and integral parameter ( $K_i$ ), respectively. The membership functions are built to represent its input and output value. The fuzzy sets of two input signals are as follows: ZE = Zero, PB = Positive Big, PS = Positive Small, NB = Negative Big and NS = Negative Small, respectively. Whereas, the fuzzy sets of two output signals are as follows: S = Small, MS = Medium Small, M = Medium, MB = Medium Big and B = Big, respectively. Figure 3 and Figure 4 show the fuzzy sets and corresponding triangular MF description of two input signals and two output signals.

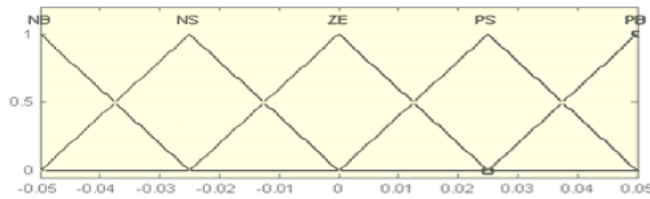

Figure 3. Membership Functions for Error (e) and Change of Error (de)

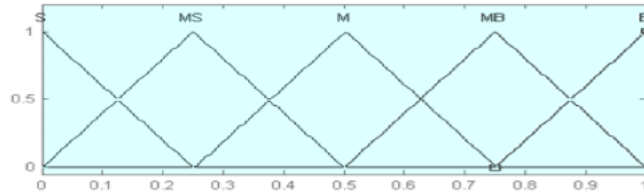

Figure 4. Membership Functions for Parameters of  $K_p$  and  $K_i$

The universes of discourse of all the membership functions are expressed in per unit values. There are five MF's for each  $e$ ,  $de$ ,  $K_p$  and  $K_i$ . The rule base of the fuzzy logic is shown in Table 1. Table 1 show that there may be  $5 \times 5 = 25$  possible rules.

Table 1. Rule base of fuzzy logic

Error (e)	Change of Error (de)				
	NB	NS	ZE	PS	PB
NB	S	S	S	MS	M
NS	S	S	MS	M	MB
ZE	S	MS	M	MB	B
PS	MS	M	MB	B	B
PB	M	MB	B	B	B

**LOAD TORQUE MODEL OF ELECTRIC PROPULSION**

In the electric propulsion system, load torque has a specific characteristic. Load torque of induction motor is torque produced by propeller which depends on its rotation speed and pitch angle. According to the work principle of propeller, the load torque produced by it can be modeled as given by Equation (4) (Faiz et al., 1999; Adnanes, A.K., 2003; Pivano et al, 2006; He-ping, H., 2007; Yu et al, 2009; Sorenson A. J., 2009).

$$T_p = K_T \rho \omega^2 D^5 \dots\dots\dots (4)$$

Where,  $K_T$ ,  $\rho$ ,  $\omega$ , and  $D$  are the propeller torque coefficients, seawater density, speed of propeller, and diameter of propeller respectively.

The ship will archive steady state condition at the ship having full load and the speed reaches the reference speed. This condition causes  $K_T$  having constant value and load torque of propeller is approximately the square of the propeller speed (Ren al., 2010; De-xi et al., 2008).

## RESULTS AND DISCUSSIONS

The effectiveness of the proposed Fuzzy-PI controller is verified by simulation process. Simulation process is conducted in conditions of normal and disturbance. The parameters of induction motor used in this simulation is as follows (in per unit, pu): 2 poles, stator resistance of 0.01, rotor resistance of 0.02, stator inductance of 0.10, rotor inductance 0.10, mutual inductance of 4.50, inertia moment of 0.30, and friction coefficient of  $1e^{-5}$ . Figure 5 shows a block diagram of simulation model.

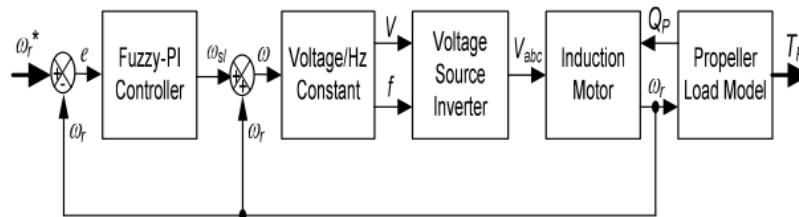

Figure 5. Block diagram of simulation model

Speed response of PI controller and Fuzzy-PI controller for speed reference of 0.8 pu is shown in Figure 6. Fuzzy-PI controller provides settling time of 0.41 s, no overshoot and small steady state error. Whereas, PI controller provides settling time of 0.49 s, overshoot of 3.75 % and also small steady state error. From their simulation results show that Fuzzy-PI controller provide the improvement of performance compared to PI controller.

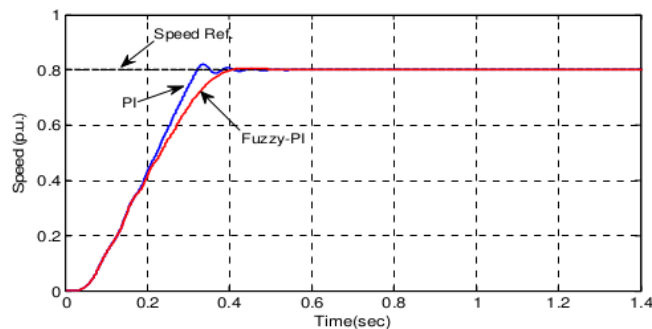

Figure 6. Speed response for normal condition

Load torque applied to the system for both controllers is shown in Figure 7. The load torques for both controllers is torque produced the propeller and depends on the propeller speed.

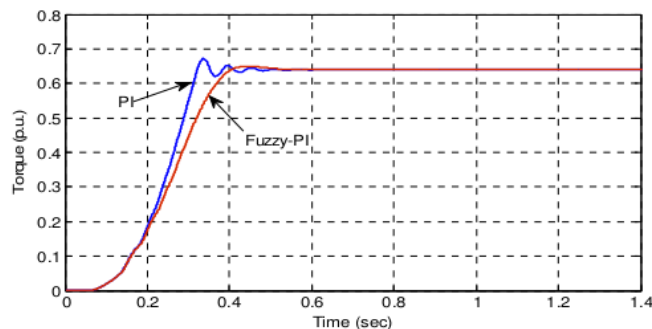

Figure 7. Load torque for normal condition



Comparison of the electromagnetic torque response between PI controller and Fuzzy-PI controller is shown in Figure 8. PI controller needs the greater electromagnetic torque than Fuzzy-PI controller. This electromagnetic torque is used by PI controller to rapidly achieve the speed reference, however it causes speed oscillation.

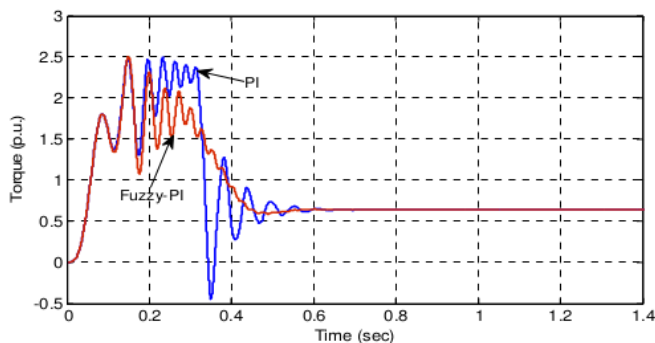

Figure 8. Electromagnetic torque response for normal condition

Current of induction motor for PI controller and Fuzzy-PI controller are shown in Figure 9 and Figure 10. Both figures show that change of electromagnetic cause change of induction motor current.

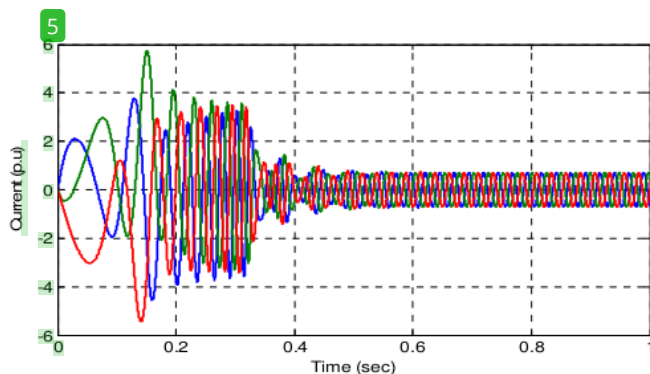

Figure 9. Current of Induction Motor with PI Controller

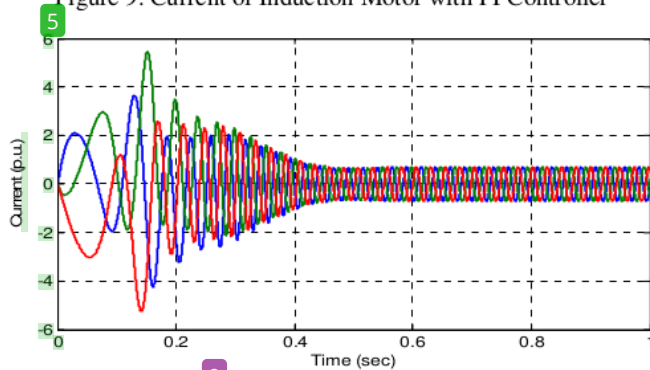

Figure 10. Current of Induction Motor with Fuzzy-PI Controller

Voltage source of induction motor for PI controller and Fuzzy-PI controller are shown in Figure 11 and Figure 12. Both figures show that change of induction motor speed cause change of voltage source frequency and magnitude of voltage source from the inverter.

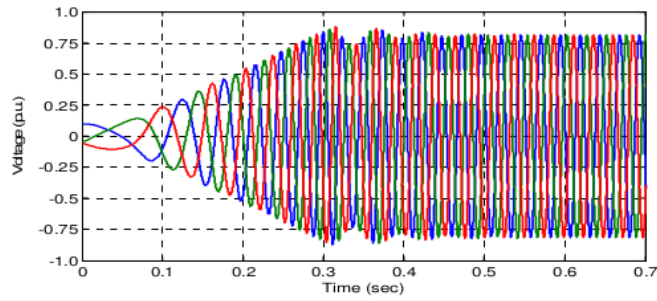

Figure 11. Voltage of Induction Motor with PI Controller

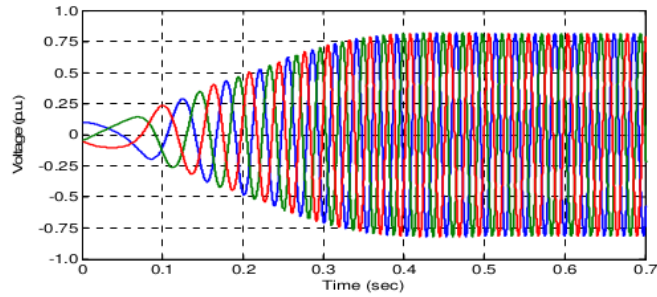

Figure 12. Voltage of Induction Motor with Fuzzy-PI Controller

For disturbance conditions, the load torque of induction motor suddenly changes 0.05 pu at  $t = 1.6$  s and also returns again at  $t = 1.7$  s. Change of load torque affect the electromagnetic torque of induction motor shown in Figure 13. PI controller requests the greater electromagnetic torque than Fuzzy-PI Controller. Disturbance also causes change of induction motor speed shown in Figure 14. Simulation result shows that speed error for PI controller is better than Fuzzy-PI controller but PI Controller still provide speed fluctuation.

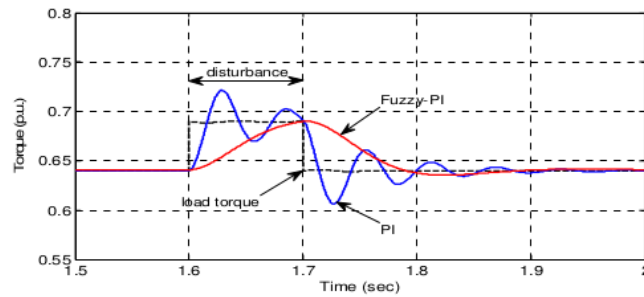

Figure 13. Electromagnetic torque for disturbance condition

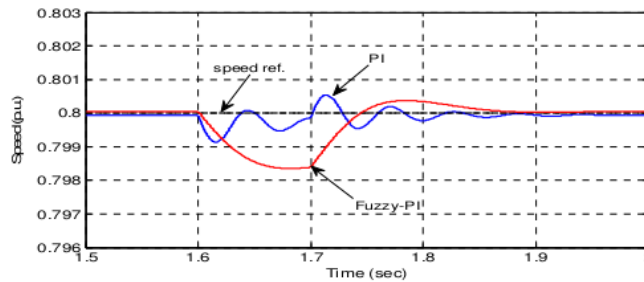

Figure 14. Speed responses for disturbance condition



## CONCLUSION

Constant V/f method based on the induction motor for electrically driven ship propeller has been presented and discussed. Fuzzy logic technique is used to adjust the parameters of PI controller ( $K_p$  and  $K_i$ ). Adaptive process in fuzzy logic (FL) can make improvement of PI controller whenever there are changing parameters caused by change of load torque. Load torque applied to the induction motor uses the electric propulsion system which depends on the rotor speed of the induction motor. The effectiveness of Fuzzy-PI controller is verified by simulation process. Fuzzy-PI controller has better performance compared to PI controller. Simulation results of Fuzzy-PI controller show that the induction motor rapidly reaches the speed reference, has small steady state error and overshoot. And also reduce speed oscillation during load disturbance condition.

## ACKNOWLEDGEMENTS

This paper is supported and funded by Directorate General of Higher Education, Ministry of Education and Culture of Republic of Indonesia through Coordination of Public Higher Education, Region VII, East Java (contract number: 008/SP2H/P/K7/KM/2014).

## REFERENCES

- [1] Adnanes, A. K. (2003). *Maritime Electrical Installations and Diesel Electric Propulsion*. Oslo: ABB AS Marine.
- [2] De-xi et al. (2008). Study on DTC-SVC of PMSM based on propeller load characteristic. *Proceedings of the 7<sup>th</sup> World Congress on Intelligent Control and Automation, Chongqing, China*: 6445-6449.
- [3] Faiz et al. (1999). Direct torque control of induction motor for electric propulsion systems. *Electric Power Systems Research*, 51, 95-101.
- [4] Gadoue et al (2009). Artificial intelligence-based speed control of DTC induction motor drives – A comparative study. *Journal Electric Power System Research*, 79, 210-219.
- [5] He-ping, H. (2007). The development trend of green ship building technology. *Asian Shipbuilding Experts Forum for International Maritime Technical Initiative (ASEF2007)*. <http://www.asef2007.com/pdf/documents>
- [6] Ioannides et al. (2003). Implementation of Scalar Control Scheme for Variable Frequency Induction Motor Actuator System. *Sensor and Actuator*, 106, 306-309.
- [7] Khan, M., & Kar, N. C. (2007). Performance analysis of fuzzy based indirect field oriented control of induction motor drives for hybrid electric vehicles. *Plugin Highway Conference*.
- [8] Kohlrusz, G., & Fodor, D. (2011). Comparison of Scalar and Vector Control Strategies of Induction Motors. *Hungarian Journal of Industrial Chemistry, Veszprem*, 39(2), 265-270.
- [9] Nour et al. (2008). Self-Tuning of PI Speed Controller Gains Using Fuzzy Logic Controller. *Modern Applied Science*, 2(6), 55-65.
- [10] Olewi et al. (2013). Position Control for (PPDCV) Using PID and Fuzzy Supervisory Controller. *Academic Research International (ARInt.)*, 4(5), 110-128.

- [11] Oros et al. (2006). *Scalar Speed of a dq Induction Motor Model Using Fuzzy Logic Controller*. <http://www.frc.utn.edu.ar/jar2006/doc/Papers>
- [12] Pedro Nuno da Costa Neves & Afonso, J.L. (2006). Traction System for Electric Vehicles Using a Variable Frequency Three Phase Induction Motor Driver with Regenerative Breaking. *3<sup>rd</sup> International Convergence on Hands-on Science – Science Education and Sustainable Development, Braga, Portugal*.
- [13] Pham et al. (2012). Self-Tuning Fuzzy PI-Type Controller in Z-Source Inverter for Hybrid Electric Vehicles. *Int. Journal of Power Electronics and Drive Systems (IJPEDS), Malaysia*, 2(4), 353-363.
- [14] Pivano et al. (2006). Marine propeller thrust estimation in four-quadrant operation. *45<sup>th</sup> IEEE Conference on Decision and Control, San Diego, CA*: 1333-1338.
- [15] Purwahyudi et al. (2011). Feed-forward Neural Network for Direct Torque Control of Induction Motor. *International Journal of Innovative Computing, Information and Control (IJICIC)*, 7(11), 6135-6145.
- [16] Purwahyudi et al. (2011). Neural Network Technique for Direct Torque Control of Induction Motor Used in Electrically Driven Marine Propeller. *International Journal of Academic Research (IJAR)*, 3(5), 358-364.
- [17] Purwahyudi et al. (2013). *Fuzzy Logic Controller for Volts/Hz Induction Motor Control Used in Electrically Driven Marine Propeller*. *Academic Research International (ARInt.)*, 4(5), 258-264.
- [18] Ren et al. (2010). Simulation of PMSM vector control system based on propeller load characteristic. *International conference on Intelligent Control and Information Processing, Dalian, China*: 735-737.
- [19] Sorenson, A. J. & Smogeli, O. N. (2009). “Torque and Power Control of Electrically Driven Marine Propeller.” *Control Engineering Practice*, 17, 1053-1064.
- [20] Tunyasrirut et al (2008). *Fuzzy Logic Control for a Speed Control of Induction Motor using Space Vector Pulse Width Modulation*. *International Journal of Engineering and Applied Sciences*, 4(1), 43-49.
- [21] Win et al (2008). *Analysis of Variable Frequency Three Phase Induction Motor Drive*. *World Academy, Engineering and Technology (WASET)*, 42, 647-651.
- [22] Yu et al (2009). Nonlinear dynamics of a simplified engine-propeller system. *Communication in Nonlinear Science and Numerical Simulation*, 14(7), 3149-3169.
- [23] Zerikat et al. (2005). Dynamic fuzzy-neural network controller for induction motor drive. *Proceeding of World Academy of Science, Engineering and Technology (PWASET)*, 10, 278-283.

# Self-Tuning Fuzzy–Pi Controller in VoltsHz Induction Motor Control For Electrically Driven Ship Propeller

---

ORIGINALITY REPORT

---

19%

SIMILARITY INDEX

---

## PRIMARY SOURCES

---

1	<a href="http://osc.medcom.id">osc.medcom.id</a> Internet	66 words — 3%
2	<a href="http://prostoma.pl">prostoma.pl</a> Internet	56 words — 2%
3	<a href="http://eprints.uthm.edu.my">eprints.uthm.edu.my</a> Internet	50 words — 2%
4	<a href="http://www.ijert.org">www.ijert.org</a> Internet	34 words — 1%
5	<a href="http://ro.ecu.edu.au">ro.ecu.edu.au</a> Internet	30 words — 1%
6	<a href="http://journals.savap.org.pk">journals.savap.org.pk</a> Internet	26 words — 1%
7	<a href="http://fr.scribd.com">fr.scribd.com</a> Internet	25 words — 1%
8	<a href="http://www.researchgate.net">www.researchgate.net</a> Internet	25 words — 1%
9	<a href="http://www.iaescore.com">www.iaescore.com</a> Internet	20 words — 1%

- 
- 10 doi.org  
Internet 18 words — 1%
- 
- 11 iieta.org  
Internet 16 words — 1%
- 
- 12 DURANAY, Zeynep Bala and GÜLDEMİR, Hanifi.  
"Bir Fazlı Asenkron Motor V/f Hız Kontrolü", Fırat  
Üniv. Fen Bilimleri Enst., 2017.  
Publications 12 words — < 1%
- 
- 13 www.hindawi.com  
Internet 12 words — < 1%
- 
- 14 Leena Yliniemi. "Chapter 8 Adaptive Fuzzy  
Control of a Rotary Dryer", Springer Science and  
Business Media LLC, 2001  
Crossref 10 words — < 1%
- 
- 15 T. Javasingh. "Improved design of FLC for a first  
order nonlinear processes with dead time",  
International Conference on Intelligent Sensing and Information  
Processing 2004 Proceedings of, 2004  
Crossref 10 words — < 1%
- 
- 16 www.ijfis.org  
Internet 10 words — < 1%
- 
- 17 Space vector Modulation (SVM) is a technique used  
for generating alternating current waveforms to  
control pulse width modulation signals (PWM). It provides  
better results of PWM signals compared to other techniques.  
CORDIC algorithm calculates hyperbolic and trigonometric  
functions of sine, cosine, magnitude and phase using bit shift,  
addition and multiplication operations. <p> This thesis  
implements SVM with Arduino Microcontroller using CORDIC  
9 words — < 1%

algorithm. This algorithm is used to calculate the PWM timing signals which are used to control the motor. Comparison of the time taken to calculate sinusoidal signal using Arduino and CORDIC algorithm was also done.<p>. "M.S.", Proquest, .

ProQuest

---

18 [emitter.pens.ac.id](http://emitter.pens.ac.id) 9 words — < 1%  
Internet

---

19 [link.springer.com](http://link.springer.com) 9 words — < 1%  
Internet

---

20 [pserc.wisc.edu](http://pserc.wisc.edu) 9 words — < 1%  
Internet

---

21 [www.jourlib.org](http://www.jourlib.org) 9 words — < 1%  
Internet

---

22 [www.scs-europe.net](http://www.scs-europe.net) 9 words — < 1%  
Internet

---

23 [www.cigre.ru](http://www.cigre.ru) 8 words — < 1%  
Internet

---

24 Wang, Xiangming, Qinghe Wang, and Leishu Dong. "Research on Control Approach of DTC Based on SVPWM and Fuzzy Control for Asynchronous Wind Power Generator", 2011 International Conference on Computational and Information Sciences, 2011. 7 words — < 1%  
Crossref

---

EXCLUDE QUOTES ON

EXCLUDE MATCHES OFF

EXCLUDE BIBLIOGRAPHY ON