

Mitigation Voltage Sag/Swell and Harmonics Using DVR Supplied by BES and PV System

By Amirullah Amirullah

Mitigation Voltage Sag/Swell and Harmonics Using DVR Supplied by BES and PV System

Agus Kiswantonu
Electrical Engineering Study Program
Faculty of Engineering
University of Bhayangkara Surabaya
Surabaya, Indonesia
kiswantonu@gmail.com

Eko Prasetyo
Informatics Engineering Study Program
Faculty of Engineering
University of Bhayangkara Surabaya
Surabaya, Indonesia
eko@ubhara.ac.id

Amirullah
Electrical Engineering Study Program
Faculty of Engineering
University of Bhayangkara Surabaya
Surabaya, Indonesia
amirullah@ubhara.ac.id
amirullah.ubhara.surabaya@gmail.com

Abstract—This paper presents mitigation voltage sag/swell and harmonics in low voltage distribution network using Dynamic Voltage Restorer (DVR) supplied by Battery Energy Storage (BES) and Photovoltaic (PV) system. This combination is called DVR-BES-PV and it is compared to DVR-Capacitor (Cap), DVR-BES, and DVR-Cap-PV. The unit vector template generation (UVTG) method is used to control series active filter at DVR when it injects compensation voltage during voltage sag/swell disturbance. The DVR-BES-PV is able to generate the lowest percentage of sag/swell and its value has met IEEE 1159. This combination is also capable to result the lowest average Total Harmonics Distortion (THD) of load voltage and its value has fulfilled limit prescribed in IEEE 519. Therefore, combination of DVR-BES-PV is able to result the best performance in mitigation of sag/swell and harmonics on load bus compared to the other three DVR combinations. Simulation and analysis of this paper uses Matlab/Simulink environment.

Keywords—Sag/Swell, Harmonics, THD, DVR, BES, PV

I. INTRODUCTION

The lack of fossil energy source and increased awareness of environmental impacts, causes renewable energy sources i.e. PV and wind to grow rapidly as an alternative energy to generate electricity. The power generated by PV is DC, so it requires an inverter before it is operated and it is connected to distribution network. Even though PV is able to supply power to grid [5] also weakness: it generates harmonics due to the existence of a voltage source inverter (VSI) on the active filter series so can reduce power quality. On the other hand with increased penetration of sensitive loads, causing power quality problems in distribution system has increased significantly. The most serious and frequent disturbances in grid voltage are sag, swell, and short-circuit. The sag is a decrease in rms voltage value between 10-90% which lasts from one half cycle to one minute. The swell is an increase in source rms voltage in a short time interval whose value ranges from 1.1 pu to 1.8 pu from nominal source voltage. The device effectively and comprehensively capable to mitigate sag/swell fault is DVR. Investigation on sag compensation using DVR with UVTG method has been done [1]. The DVR is able to compensate for balanced and unbalanced sag and inject desired voltage component to rapidly repair a number of disruption anomalies alongside source voltage to keep load voltage constant and balanced at nominal value. However, that research has not discussed mitigation voltage swell and harmonics due to presence of sensitive voltage devices on load side.

The comparative analysis of compensation techniques i.e. phase-compensation method, pre-dip compensation method (called compensation of large voltage difference) and intelligent phase compensation method have been investigated [2]. Laboratory based testing with a number of disturbance scenarios including sag on source side and load power factor have been performed as validation of results

against each proposed method. Investigation model for self-supported DVR control has been proposed by [3]. The three of three phase harmonics filters (double tuned) are used for harmonic migration generated by a voltage source converter (VSC). The research shows that low-rating DVR can compensate for sag/swell and reduce voltage THD on load bus according to IEEE 519. DVR performance to sag and load voltage harmonics using Sinusoidal Pulse control Width Modulation (SPWM) and Space Vector Pulse Width Modulation (SVPWM) has been researched by [4]. The Synchronous Reference Frame (SRF) method has been used to detect sag voltage and to generate modulation signal. The research shows that load voltage THD using SVPWM is smaller than SPWM method. Nevertheless, performance of SVPWM and SPWM with load voltage swell is not discussed in this work. The configuration integration of grid connected PV system together self-supported DVR has been proposed [5]. The system is called the "six-port converter," a whole composed of nine semiconductor switches which it is reduced from the previous 12 semiconductors. The configurations are capable to operate in different modes based on grid condition and PV generation power. The research mode is the normal grid mode, the fault mode, the sag mode, and the non-active PV mode.

The DVR consists of an injection transformer, a series active filter, a DC voltage source, and an energy storage. The energy storage commonly used is a DC link capacitor. The weakness of this device has limited energy storage capacity. In order to overcome these problem, this paper has proposed implementation of BES supplied by PV to mitigate sag/swell and harmonics on low voltage distribution network. This combination is called DVR-BES-PV and installed on three phase distribution lines to maintain voltage on sensitive load. The advantage of BES has a larger storage capacity than the capacitor. Otherwise, PV can be used as an alternative DC voltage source to charge BES when its capacity reduced and provides active power required for compensation when voltage sag/swell. The UVTG method is used to control series active filter in DVR when it injects compensation voltage during voltage sag/swell disturbance. The nominal percentage of voltage sag on sources bus are 20%, 40%, 60%, and 80%. Then, the nominal percentage of voltage swell on sources bus are 120%, 140%, 160%, and 180%. This research is performed on percentage of voltage sag/swell and voltage THD on load bus based on DVR circuit configuration and disturbance scenarios which determined before. The effectiveness of proposed combination then is compared to three DVR combinations i.e. DVR-Cap, DVR-BES, DVR-Cap-PV. Furthermore, the results are compared and validated with IEEE 1159 and IEEE 519.

II. RESEARCH METHOD

A. Proposed Method

Fig. 1 shows proposed model of DVR using BES supplied by PV. This model is located between source or point common coupling (PCC) bus and load bus connected to sensitive load. Then, the PCC bus is connected to a three phase grid through a 380 V and 50 Hz three phase low voltage distribution line. The DVR circuit consists of an injection transformer, filter circuit, active series filter, DC voltage source, and energy storage. Energy storage used previously is a DC link capacitor circuit. The weakness of the capacitor has limited energy storage capacity. The PV produces output voltage and becomes as input for DC/DC boost converter. The MPPT with Perturb and Observer (P and O) algorithm further helps single phase PV to generate the maximum power. The DC output voltage of PV is relatively low value and then raised by the boost DC/DC converter at appropriate voltage level in order to generate active power to charge BES.

The BES has a larger storage capacity than the capacitor, while PV generator is used as an alternative source of DC voltage to fill the BES as its capacity decreases and provides active power required for compensation when voltage sag/swell occurs. The PV help self-charging process of BES from the system during no fault (stand by mode). The series active filter component of DVR is controlled UVTG method to maintain voltage between source and load bus so that voltage becomes balanced, distortion free, and kept its

magnitude steady. The UVTG method is also used to generate a trigger pulse in a six-pulse width modulation (PWM) circuit required by series active filters, thus generating an injection voltage to compensate for voltage sag/swell on load bus. The devices and simulation parameters of proposed model are presented in Appendix.

This paper proposes mitigation voltage sag/swell and harmonics using DVR supplied by BES and PV system connected to distribution network. The DVR is located between load bus and source (PCC) bus through a 380 V and 50 Hz low voltage distribution line. There are four DVR combination i.e. DVR-Cap, DVR-BES, DVR-Cap-PV, and DVR-BES-PV. Each combination has two disturbance scenarios are voltage sag and voltage swell which generate 33 on source bus respectively. The nominal percentage of voltage sag disturbances are 20%, 40%, 60%, and 80%. Then for percentage of voltage swell disturbances are 120%, 140%, 160%, and 180%. The analysis of research is performed on percentage of voltage sag, voltage swell, and voltage harmonics on load bus based on DVR circuit configuration and disturbance scenarios which determined before. In order to verify the effectiveness and advantages of DVR supplied by BES and PV system, this model is compared to the other of three DVR combinations. Then, the results are compared and validated with IEEE 1159 for voltage disturbance standards and IEEE 519 for power quality standards [6-10]. Simulation and analysis of this project uses Matlab/Simulink environment.

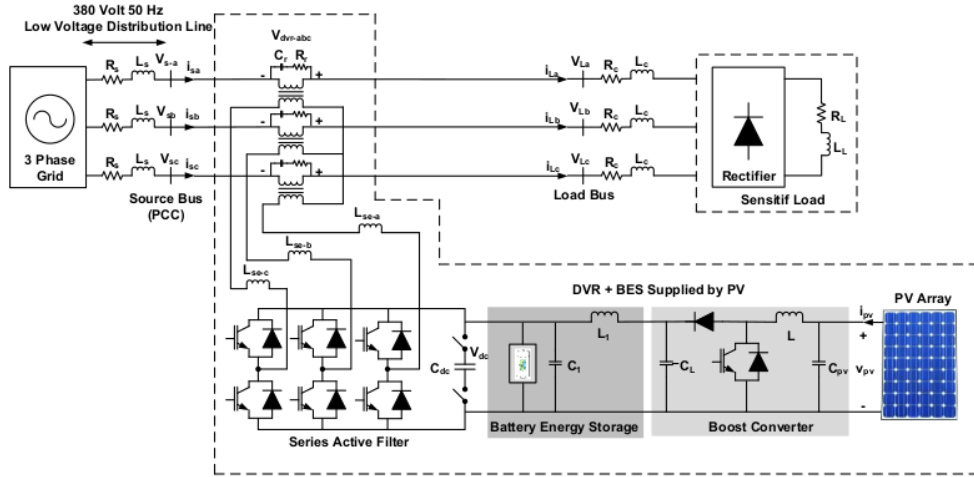

Fig. 1. Proposed model of DVR using BES supplied by PV

B. Model of PV Array

Fig. 2 shows the equivalent circuit of a solar panel. A solar panel is composed by several PV cells that have series, parallel, or series-parallel external connections [11]. The V-I characteristic of a solar panel is showed in (1):

$$I = I_{pv} - I_o \left[\exp\left(\frac{V + R_s I}{aV_t}\right) - 1 \right] - \frac{V + R_s I}{R_p} \quad (1)$$

Where I_{pv} is the photovoltaic current, I_o is saturated reverse current, 'a' is the ideal diode constant, $V_t = N_s K T q^{-1}$ the thermal voltage, N_s is the number of series cells, q is the electron charge, K is the Boltzmann constant, T is the

temperature of p-n junction, R_s and R_p are series and parallel equivalent resistance of the solar panels. I_{pv} has a linear relation with light intensity and also varies with temperature variations. I_o is dependent on temperature variations. The values of I_{pv} and I_o are calculated as following (2) and (3):

$$I_{pv} = (I_{pv,n} + K_1 \Delta T) \frac{G}{G_n} I \quad (2)$$

$$I_o = \frac{I_{sc,n} + K_2 \Delta T}{\exp(V_{oc,n} + K_3 \Delta T) / aV_t - 1} \quad (3)$$

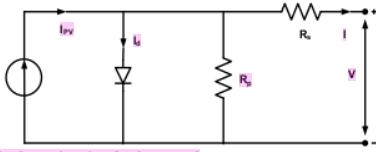

Fig. 2. Equivalent circuit of solar panel

In which $I_{PV,n}$, $I_{SC,n}$ and $V_{OC,n}$ are photovoltaic current, short circuit current and open circuit voltage in standard conditions ($T_n = 25\text{ C}$ and $G_n = 1000\text{ Wm}^{-2}$) respectively. K_I is the coefficient of short circuit current to temperature, $\Delta T = T - T_n$ is the temperature deviation from standard temperature, G is the light intensity and K_V is the ratio coefficient of open circuit voltage to temperature. Open circuit voltage, short circuit current and voltage-current corresponding to the maximum power are three important points of I-V characteristic of solar panel. These points are changed by the variations of atmospheric conditions. By using (4) and (5) which are derived from PV model equations, short circuit current and open circuit voltage can be calculated in different atmospheric conditions.

$$I_{SC} = (I_{SC} + K_I \Delta T) \frac{G}{G_n} \quad (4)$$

$$V_{OC} = V_{OC} + K_V \Delta T \quad (5)$$

C. UVTG Method in Controlling Series Active Filter

The main function of series active filter is the sensitive load protection against a number of voltage disturbances at source bus. The control strategy algorithm of the source and load voltage in series active filter is shown in Fig. 3. It extracts the UVTG from the distorted input supply. Furthermore, the templates are expected to be ideal sinusoidal signal with unity amplitude. The distorted supply voltages are measured and divided by peak amplitude of fundamental input voltage V_m given in (6) [12].

$$V = \sqrt{\frac{2}{3}(V_{sa}^2 + V_{sb}^2 + V_{sc}^2)} \quad (6)$$

A three phase locked loop (PLL) is used in order to generate sinusoidal unit vector templates with a phase lagging by the use of sinus function. The reference load voltage signal is determined by multiplying the unit vector templates with the peak amplitude of the fundamental input voltage V_m . The load reference voltage (V_{La}^* , V_{Lb}^* , V_{Lc}^*) is then compared to the sensed load voltage (V_{La} , V_{Lb} , V_{Lc}) by a PWM controller used to generate the desired trigger signal on series active filter.

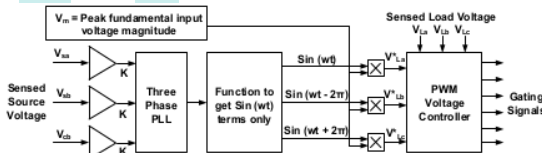

Figure 3. UVTG control of series active filter

D. Voltage Sag/Swell

The voltage sag is defined as a decrease in the value of rms voltage between 10-90% which goes on from one half cycle to one minute. The voltage sag can affect to the phase or amplitude. The most voltage sag occurs caused by a single phase to ground short circuit. An unbalanced short

circuit can trigger an unbalanced phase and shift it from its nominal value. The starting of motor with high power also can generate voltage sag. The amplitude of the voltage sag depends on several factors i.e. type, location, and impedance disturbance. The voltage sag in each busbar is different depends on location of disturbance. The duration of sag is determined by duration of protection clearing time i.e. the extent to which voltage sag is able to be removed.

The voltage swell is an increase in source voltage in short time intervals whose value ranges from 1.1 pu to 1.8 pu from nominal source voltage. Although the duration time of voltage sag/swell is short, the interference can affect sensitive loads such as the computers, the programmable logic controllers (PLCs) and the variable speed drives (VSDs) on motor and simultaneously reducing efficiency of these devices. The DVR is a special power electronics device used to reduce voltage sag/swell. The DVR is able to protect sensitive loads that may be drastically affected by voltage fluctuations in the distribution system. The recommended standard of practice on monitoring voltage sag/swell as the part of electric power quality parameters is IEEE 1159-1995 [14]. This standard presents definition and table of voltage sag/voltage base on categories (instantaneous, momentary, temporary) typical duration, and typical magnitude. The percentage of voltage sag is formulated in (7) [15] and with the same procedure, the authors propose (8) for percentage of voltage swell.

$$\text{Sag}(\%) = \frac{V_{pre\ sag} - V_{sag}}{V_{pre\ sag}} \quad (7)$$

$$\text{Swell}(\%) = \frac{|V_{pre\ swell} - V_{swell}|}{V_{pre\ swell}} \quad (8)$$

III. RESULT AND DISCUSSION

The analysis of the proposed model is performed through the determination of four combinations circuit i.e. without DVR, DVR-Cap, DVR-BES, DVR-Cap-PV, and DVR-BES-PV. Each combination has two scenarios are sag and swell voltages which generated by disturbance on source bus. The nominal percentage of voltage sag are 20%, 40%, 60%, and 80%. Then, for voltage swell are 120%, 140%, 160%, and 180%. The DVR combination is installed on a three phase distribution line to maintain voltage on sensitive load. By using Matlab/Simulink, then this proposed model is run based on the desired scenario to obtain curve of source voltage (V_s) and load voltage (V_L), voltage sag percentage (%), and voltage swell percentage (%) using (7) and (8) with pre voltage sag/swell equal as 309.3 V. Furthermore, source voltage THD and load voltage THD in each phase, as well as their average values are also determined based on obtained curve before. The total duration time of simulation occurs for 0.2 seconds with duration of sag/swell voltage disturbance between 0.06-0.14 s. The voltage THD in each phase is determined in one cycle started at $t = 0.1$ s. Furthermore, the percentage of load voltage sag (%), average THD of source voltage, and average THD of load voltage in each combinations and scenarios are presented in Table 1. By using the same procedure, for voltage swell disturbances, the parameters and their simulated results are also shown in Table 2. Fig. 4 and Fig. 5 present load voltage performance of 60% sag and 160% swell with four different scenarios.

TABLE I. PERCENTAGE OF LOAD VOLTAGE SAG AND VOLTAGE HARMONICS

Scenarios	Source Voltage V_s (V)			Load Voltage V_L (Volt)			Sag (%)	Source Voltage THD (%)				Load Voltage THD (%)			
	Ph A	Ph B	Ph C	Ph A	Ph B	Ph C		Ph A	Ph B	Ph C	Avg	Ph A	Ph B	Ph C	Avg
Without DVR															
20% Sag	247.5	247.5	247.5	247.5	247.5	247.5	20	0.19	0.19	0.19	0.19	0.19	0.19	0.19	0.19
40% Sag	185.6	185.6	185.6	185.6	185.6	185.6	40	0.19	0.19	0.19	0.19	0.19	0.19	0.19	0.19
60% Sag	123.7	123.7	123.7	123.7	123.7	123.7	60	0.18	0.18	0.18	0.18	0.18	0.18	0.18	0.18
80% Sag	61.87	61.87	61.87	61.87	61.87	61.87	80	0.18	0.18	0.18	0.18	0.18	0.18	0.18	0.18
DVR+Cap															
20% Sag	247.5	247.5	247.5	242.0	242.0	242.0	21.76	0.18	0.18	0.18	0.18	8.24	8.24	8.24	8.24
40% Sag	185.6	185.6	185.6	181.5	181.5	181.5	41.29	0.18	0.18	0.18	0.18	8.24	8.24	8.23	8.24
60% Sag	123.7	123.7	123.7	121.0	121.0	121.0	60.88	0.18	0.18	0.18	0.18	8.22	8.23	8.22	8.22
80% Sag	61.87	61.87	61.87	60.52	60.52	60.42	80.43	0.18	0.18	0.18	0.18	8.17	8.19	8.16	8.17
DVR+BES															
20% Sag	247.3	247.3	247.3	303.3	300.9	300.2	2.54	0.23	0.23	0.23	0.23	3.88	3.85	3.76	3.83
40% Sag	185.2	185.2	185.3	304.1	299.1	298.8	2.80	0.30	0.31	0.30	0.30	2.96	3.92	3.97	3.62
60% Sag	123.2	123.2	123.2	300.2	297.5	298.2	3.45	0.43	0.45	0.44	0.44	4.14	4.32	4.71	4.39
80% Sag	61.13	61.13	61.13	301.4	299.0	299.4	3.03	0.93	0.93	0.93	0.93	3.95	4.82	3.91	4.23
DVR+Cap+PV															
20% Sag	247.3	247.3	247.3	293.0	293.1	293.2	5.24	0.20	0.20	0.20	0.20	5.02	4.96	5.03	5.00
40% Sag	185.4	185.4	185.4	240.6	240.6	240.6	22.21	0.23	0.23	0.23	0.23	13.39	13.38	13.39	13.39
60% Sag	123.5	123.5	123.5	186.3	186.2	186.3	39.76	0.28	0.28	0.28	0.28	16.23	16.36	16.35	16.32
80% Sag	61.65	61.65	61.64	133.0	132.8	133.2	60.00	0.43	0.43	0.43	0.43	21.12	21.34	21.25	21.24
DVR+BES+PV															
20% Sag	247.3	247.3	247.3	310.2	310.2	310.2	0.29	0.23	0.23	0.23	0.23	0.37	0.37	0.37	0.37
40% Sag	185.2	185.2	185.2	310.2	310.2	310.2	0.29	0.31	0.31	0.31	0.31	0.38	0.36	0.34	0.36
60% Sag	123.2	123.2	123.2	310.1	307.8	307.8	0.24	0.47	0.46	0.47	0.47	0.39	1.87	1.84	1.36
80% Sag	61.11	61.14	61.17	308.6	297.0	295.5	2.89	0.89	0.89	0.91	0.89	2.14	7.86	7.41	5.81

TABLE II. PERCENTAGE OF LOAD VOLTAGE SWELL AND VOLTAGE HARMONICS

Scenarios	Source Voltage V_s (Volt)			Load Voltage V_L (Volt)			Swell (%)	Source Voltage THD (%)				Load Voltage THD (%)			
	Ph A	Ph B	Ph C	Ph A	Ph B	Ph C		Ph A	Ph B	Ph C	Avg	Ph A	Ph B	Ph C	Avg
Without DVR															
120% Swell	371.2	371.2	371.2	371.2	371.2	371.2	20.0	0.19	0.19	0.19	0.19	0.19	0.19	0.19	0.19
140% Swell	433.1	433.1	433.1	433.1	433.1	433.1	40.0	0.19	0.19	0.19	0.19	0.19	0.19	0.19	0.19
160% Swell	494.9	494.9	494.9	494.9	494.9	494.9	60.0	0.19	0.19	0.19	0.19	0.19	0.19	0.19	0.19
180% Swell	556.8	556.8	556.8	556.8	556.8	556.8	80.0	0.19	0.19	0.19	0.19	0.19	0.19	0.19	0.19
DVR-Cap															
120% Swell	371.4	371.4	371.4	327.2	329.1	324.4	5.69	0.15	0.15	0.15	0.15	8.95	9.12	8.47	8.47
140% Swell	433.4	433.4	433.4	335.9	339.3	331.7	8.51	0.13	0.13	0.13	0.13	8.78	8.84	8.85	8.85
160% Swell	495.3	495.4	495.4	360.5	360.2	356.1	16.05	0.11	0.11	0.12	0.11	8.47	8.35	8.02	8.02
180% Swell	557.3	557.3	557.3	397.0	398.2	392.1	27.96	0.12	0.12	0.12	0.12	5.70	5.94	5.84	5.84
DVR-BES															
120% Swell	371.4	371.4	371.4	302.3	303.7	305.8	1.74	0.15	0.15	0.15	0.15	3.89	3.68	3.85	3.81
140% Swell	433.4	433.4	433.4	304.9	306.3	307.6	0.98	0.13	0.13	0.13	0.13	2.59	2.70	2.16	2.48
160% Swell	495.5	495.5	495.5	306.6	308.6	308.6	0.44	0.12	0.12	0.12	0.12	3.29	2.95	2.96	3.07
180% Swell	557.5	557.5	557.5	310.3	310.3	309.6	0.24	0.10	0.10	0.10	0.10	3.19	2.74	3.13	3.02
DVR-Cap+PV															
120% Swell	371.4	371.4	371.4	310.5	310.6	310.5	0.40	0.16	0.16	0.16	0.16	0.35	0.34	0.34	0.34
140% Swell	433.4	433.4	433.4	311.5	311.7	311.5	0.74	0.13	0.13	0.13	0.13	0.43	0.45	0.45	0.45
160% Swell	495.4	495.4	495.4	336.3	338.9	333.5	8.71	0.12	0.12	0.12	0.12	5.32	5.88	5.73	5.64
180% Swell	557.3	557.3	557.3	383.4	383.1	377.8	23.32	0.12	0.12	0.12	0.12	4.22	4.80	4.20	4.41
DVR-BES+PV															
120% Swell	371.4	371.4	371.4	310.3	310.4	310.4	0.35	0.16	0.16	0.16	0.16	0.37	0.37	0.37	0.37
140% Swell	433.4	433.4	433.4	310.3	310.3	310.3	0.32	0.13	0.13	0.13	0.13	0.37	0.36	0.37	0.37
160% Swell	495.5	495.5	495.5	310.4	310.4	310.5	0.37	0.12	0.12	0.12	0.12	0.36	0.37	0.37	0.37
180% Swell	557.5	557.5	557.5	310.5	310.8	311.3	0.51	0.10	0.10	0.10	0.10	0.41	0.55	0.66	0.54

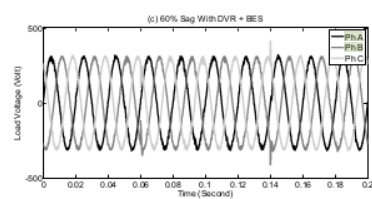
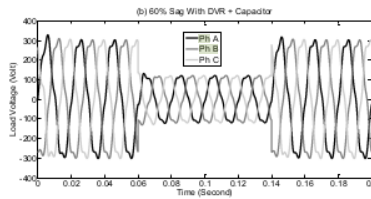
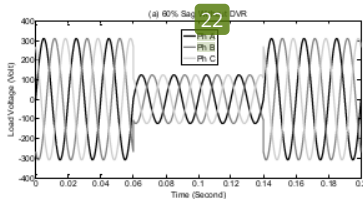

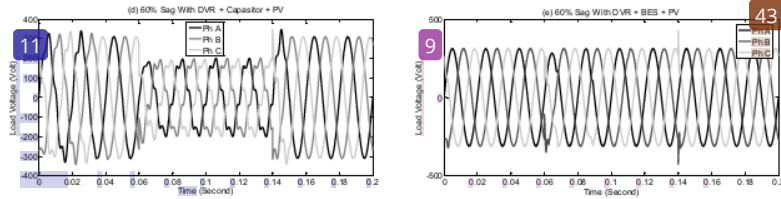

Fig. 4. Load voltage performance of 60% voltage sag

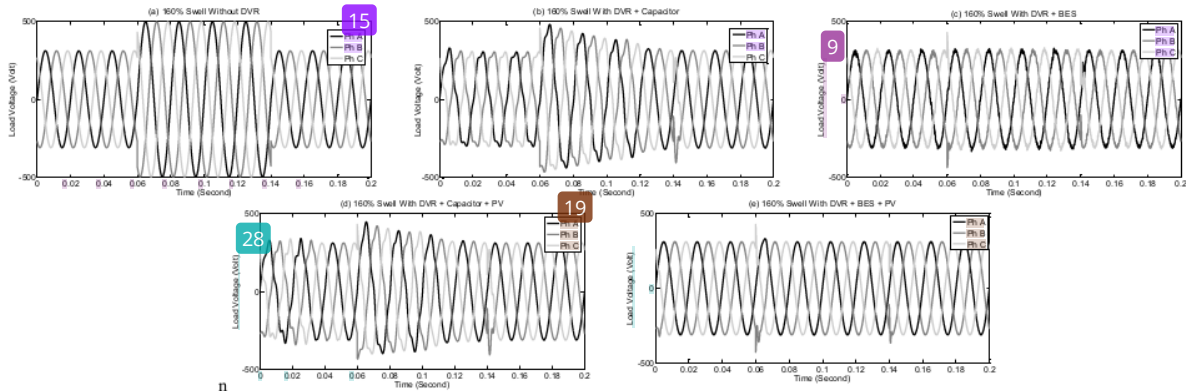

Fig. 5. Load voltage performance of 160% voltage swell

Fig. 6 and Fig. 7 show percentage of load voltage sag and load voltage swell in four DVR combinations.

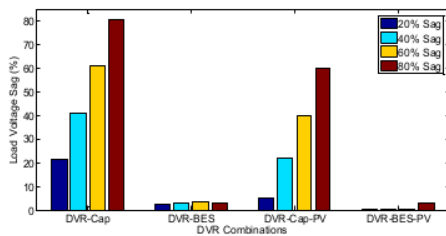

Fig. 6. Percentage of load voltage sag

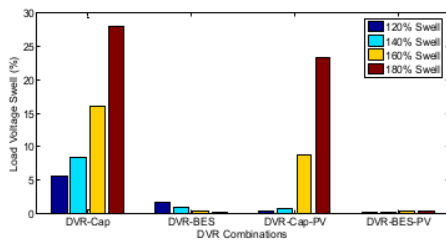

Fig. 7. Percentage of load voltage swell

Table 1 and Fig. 6 show that in four circuit scenarios using a DVR, the higher percentage of sag voltage drop on source bus then percentage of sag voltage drop on load bus is also higher. The combination of DVR-BES-PV is capable to produce the lowest percentage decrease in sag voltage compared to the other three DVR combinations. In this combination, 60% sag voltage on source bus is able to reduce percentage of sag load voltage only of 0.24%. In 12% of harmonics mitigation, combination of DVR-BES-PV is also able to produce the smallest average THD of load voltage and its value has met IEEE 519. The disturbance of 60% sag on source bus with this combination is capable of resulting an average THD of load voltage of 1.36%.

Table 2 and Fig. 7 show that in four circuit scenarios using a DVR, the higher percentage increase in swell voltage on load side is also higher. The combination of DVR-BES-PV circuit is capable to result the lowest percentage increase in swell voltage compared to the other three combinations. In this combination, disturbance of 160% swell voltage on source bus is able to raise load voltage only of 0.37%. In terms of harmonics reduction, the combination of DVR-BES-PV is also capable to produce the smallest THD and it has met the limits prescribed in IEEE 519. The disturbance of 60% swell voltage on source bus using this combination is able to produce an average THD of load voltage of 0.37%. Fig. 8 and Fig. 9 show THD of load voltage on phase A for 60% sag and 160% swell disturbance.

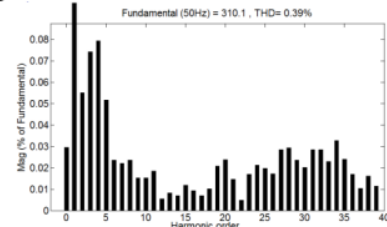

Fig. 8. THD load voltage on phase A for 60% sag

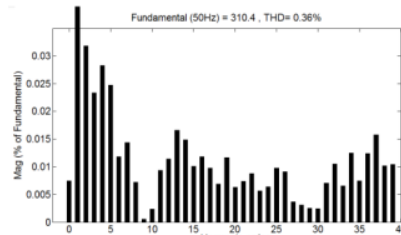

Fig. 9. THD load voltage on phase A for 160% swell

Fig. 10 shows performance of average THD of load voltage for voltage sag in four DVR combinations. Fig. 11 also shows the same performance for voltage swell.

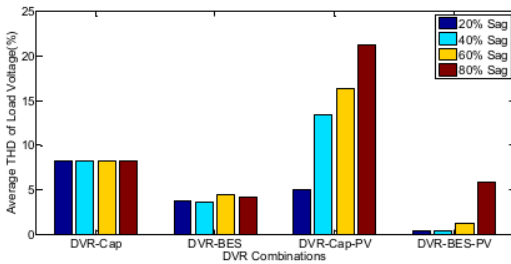

Fig. 10. Performance of average THD load voltage for voltage sag

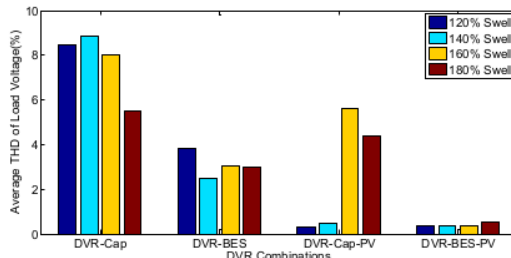

Fig. 11. Performance of average THD load voltage for voltage swell

Fig. 10 shows that in all percentage of voltage sag disturbances (20%, 40%, 60%, and 80%) on source bus, the DVR-BES-PV combination is capable to result the lowest average THD of load voltage compared to the other three combinations (DVR-Cap, DVR-BES, DVR-Cap-PV) and has met the limit of IEEE 519. Fig. 11 also shows that in all percentage of swell voltage disturbances (120%, 140%, 160%, and 180%) on source bus, the DVR-BES-PV combination is able to produce the lowest average THD of load voltage compared to other combinations and it has fulfilled the limits prescribed in IEEE 519.

IV. CONCLUSION

The application of DVR using BES and PV system on low voltage distribution network is already presented. The combination of DVR-BES-PV devices is able to generate the lowest percentage of sag/swell compared to the other three combinations and its value has met IEEE 1159. This combination is also capable to result the lowest average THD of load voltage depend on the other three combinations of DVR and its value has fulfilled the limits prescribed in IEEE 519. Finally, the combination of DVR-BES-PV is able to result the best performance in mitigation of sag/swell voltage and harmonics on load bus.

ACKNOWLEDGMENT

The authors would like to acknowledge to Directorate of Research and Community Service, Directorate General of Research and Development Strengthening, Ministry of Research, Technology, and Higher Education, Republic of Indonesia, for financial support through Beginner Lecturer Research base on Contract Number 009/SP2H/LT/K7/KM/2018 date on 26 February 2018.

APPENDIX

Three phase grid: RMS voltage = 380 volt (L-L), frequency = 50 Hz, line source impedance $R_s = 0.1$ Ohm, line source inductance $L_s = 15$ mH; Series active filter: series inductance $L_{se} = 0.015$ mH, Series transformer: kVA = 10 kVA, frequency 50 Hz, $N_1/N_2 = 1:1$; Sensite Load: load resistance $R_L = 60$ Ohm, load inductance $L_L = 0.15$ mH, line load resistance $R_c = 0.4$ Ohm, line load inductance $L_c = 15$ mH; DC link: voltage $V_{DC} = 650$ Volt, capacitance $C_{DC} = 3000$ μ F; Battery energy storage: Type = nickel metal hibrid, DC voltage = 650 V, capacity = 200 Ah, initial SOC, 100%, inductance $L_1 = 2$ mH, capacitance $C_1 = 200$ μ F; PV array active power = 0.6 kW, temperature = 25°C, irradiance = 1000 W/m².

REFERENCES

- Vijay S. Karale; Saurabh S. Jadhao; Mohan Tasare; G. M. Dhole, "UVTG based Dynamic Voltage Restorer for Mitigation of Voltage Sag", International Conference on Computing Communication Control and automation (ICCUBEA), Pune, India, pp. 1-6, 2016.
- A. Moreno-Munoz; D. Oterino; M. Gonzalez; F. A. Olivencia; J. J. Gonzalez-de-la-Rosa, "Study of Sag Compensation with DVR", IEEE Mediterranean Electrotechnical Conference (MELECON), Malaga Spain, pp. 990-993, 2006.
- Amit Kumar; Nidhi Singh Pal; M. A. Ansari, "Mitigation of Voltage Sag/Swell and Harmonics using Self-Supported DVR", First IEEE Conference on Power Electronics, Intelligent, Control and Energy Systems (ICPEICES), New Delhi, India, pp: 1-5, 2016.
- Nisha Prakash; Joffie Jacob; V. Reshmi, 2014, "Comparison of DVR performance with Sinusoidal and Space Vector PWM techniques", Annual International Conference on Emerging Research Areas: Magnetics, Machines and Drives (AICERA/iCMMD), Kottayam, India, pp. 1-6, 2014.
- Abdul Mannan Rauf and Vinod Khadkikar, "Integrated Photovoltaic and Dynamic Voltage Restorer System Configuration", IEEE Transactions on Sustainable Energy, Volume: 6, Issue: 2, pp. 400 - 410, 2015.
- 1159-1995-IEEE Recommended Practice for Monitoring Electric Power Quality, New York, USA.
- Thomas M. Bloming, P.E. and Daniel J. Carnovale, P.E., "Application of IEEE Standar 519-1992 Harmonic Limits", Presented at The 2005 IEEE IAS Pulp and Paper Industry Conference in Appleton, WI.
- Arrilaga, Jos and Watson, Neville, "Power System Harmonics", Chicester: John Willey and Sons, 2003.
- Tony Hoevenaer, P.Eng, Kurt LeDoux, P.E., Matt Colosino, 2003, "Interpreting IEEE Standard 519 and Meeting Its Harmonic Limit in VFD Application", Copyright Material IEEE Paper No. PCIC-2003-15.May, 2003.
- Sankam C, "Power Quality", CRC Press LLC, 2002.
- Amirullah and Agus Kiswanto, "Power Quality Enhancement of Integration Photovoltaic Generator to Grid under Variable Solar Irradiance Level using MPPT-Fuzzy", International Journal of Electrical and Computer Engineering (IJECE), IAES Publisher, Vol. 6, No. 6, December 2016, pp.2629-2642.
- Yahia Bouzelata, Erol Kurt, Rachid Chennai, Necmi Altun, "Design and Simulation of Unified Power Quality Conditioner Fed by Solar Energy", International Journal of Hydrogen Energy Vol. 40, Elsevier Ltd, pp. 15267-15277, 2015
- Mahmoud Zadehbagheri, Rahim Ildarabad, and Majid Baghaei Nejad, "Modeling and Simulation of Dynamic Voltage Restorer for Voltage Sag/Swell Compensation in Power Distribution Networks: A Review", International Journal of Mechatronic, Electrical, and Computer Technology, Vol. 5(16), pp. 2258-2275, July 2015.
- Richard P.Bingham, 1998, "Sags and Swells", Technology and Products Dranetz-BMI 1000, New Durham Road, pp. 3.
- Ali O Al-Mathnani, Azah Mohamed, Mohd Alauddin Mohd Ali, "Photovoltaic Based Dynamic Voltage Restorer For Voltage Sag Mitigation", 5th Student Conference on Research and Development, Selangor, Malaysia, Malaysia, pp. 1-6, 11-12 December 2007.

Mitigation Voltage Sag/Swell and Harmonics Using DVR Supplied by BES and PV System

ORIGINALITY REPORT

15%

SIMILARITY INDEX

PRIMARY SOURCES

- 1** Ali Reza Reisi, Mohammad H. Moradi, Hemen Showkati. "Combined photovoltaic and unified power quality controller to improve power quality", *Solar Energy*, 2013
Crossref 133 words — 2%

- 2** journal.uad.ac.id
Internet 88 words — 2%

- 3** Yahia Bouzelata, Erol Kurt, Rachid Chenni, Necmi Altin. "Design and simulation of a unified power quality conditioner fed by solar energy", *International Journal of Hydrogen Energy*, 2015
Crossref 52 words — 1%

- 4** aeuso.org
Internet 49 words — 1%

- 5** Satyanarayana. Vanam, B.Shiva Prasad Bharath. "Power Quality Improvement in Grid System with PV Based SVPWM-DVR for Sag & Swell Mitigation with a Novel ANN Controller", 2022 International Conference on Electronic Systems and Intelligent Computing (ICESIC), 2022
Crossref 38 words — 1%

- 6** core.ac.uk
Internet 33 words — 1%

7 Yudi Hartono, Khoirul Huda. "Development Concept of Controversial History Material in Senior High School in Indonesia", Proceedings of the 4th International Conference on Learning Innovation and Quality Education, 2020
29 words — 1%
Crossref

8 M. Sivakumar, P. Kannan, S. Chenthur Pandian. "Mitigation of PQ Issues Using an Enhanced UPQC-Based ANN Approach", Journal of Circuits, Systems and Computers, 2019
27 words — < 1%
Crossref

9 Yüksel Oğuz, İrfan Güney, Hüseyin Çalık. "Power Quality Control and Design of Power Converter for Variable-Speed Wind Energy Conversion System with Permanent-Magnet Synchronous Generator", The Scientific World Journal, 2013
24 words — < 1%
Crossref

10 www.nrel.gov
Internet
24 words — < 1%

11 www.cired-repository.org
Internet
23 words — < 1%

12 www.iaescore.com
Internet
20 words — < 1%

13 R Rajeswari, N. Karpagam, S. Dhanalakshmi. "Analysis of dq0 based fuzzy logic controller in DVR for voltage sag and harmonic mitigation", 2014 International Conference on Green Computing Communication and Electrical Engineering (ICGCCEE), 2014
16 words — < 1%
Crossref

14 cyberleninka.org
Internet
14 words — < 1%

-
- 15 peakservo.com 14 words — < 1%
Internet
-
- 16 Sai Shankar, Ashwani Kumar, W. Gao. "Operation of unified power quality conditioner under different situations", 2011 IEEE Power and Energy Society General Meeting, 2011 13 words — < 1%
Crossref
-
- 17 journals.iaumajlesi.ac.ir 13 words — < 1%
Internet
-
- 18 Kamal-Al-Haddad. "Indirect control of capacitor supported DVR for power quality improvement in distribution system", 2008 IEEE Power and Energy Society General Meeting - Conversion and Delivery of Electrical Energy in the 21st Century, 07/2008 12 words — < 1%
Crossref
-
- 19 hdl.handle.net 12 words — < 1%
Internet
-
- 20 repositories.lib.utexas.edu 12 words — < 1%
Internet
-
- 21 Pathan, Abrarkhan I., S S. Vanamane, and R. H. Chile. "Different control techniques of Dynamic Voltage Restorer for power quality problems", 2014 First International Conference on Automation Control Energy and Systems (ACES), 2014. 11 words — < 1%
Crossref
-
- 22 cos-arl.colorado.edu 11 words — < 1%
Internet
-
- 23 Raut, Prasad A., and Manohar N. Kalgunde. "An overview and design of Dynamic Voltage Restorer" 10 words — < 1%

to improve power quality in microgrid", 2015 International Conference on Energy Systems and Applications, 2015.

Crossref

24 Saman Hosseini Hemati, Ashkan Mohammadi. "Power Control of High Penetration PV in Distribution Network", TELKOMNIKA Indonesian Journal of Electrical Engineering, 2015

10 words — < 1%

Crossref

25 dr.ntu.edu.sg

Internet

10 words — < 1%

26 insightsociety.org

Internet

10 words — < 1%

27 media.neliti.com

Internet

10 words — < 1%

28 A Yuliati, E Nofiyanti. "Study of Protected Current for Stainless Steel and Carbon Steel Cathode from Rust Attack to Determining Optimum Flow of Electricity", Journal of Physics: Conference Series, 2019

9 words — < 1%

Crossref

29 Ali Teta, Abdellah Kouzou, Mohamed Mounir Rezaoui, Haitham Abu-Rub. "Interactive PV-Shunt Active Power Filter based on Impedance Source Inverter Controlled by SRF-MVF", 2021 18th International Multi-Conference on Systems, Signals & Devices (SSD), 2021

9 words — < 1%

Crossref

30 Muhammad Alif Mansor, Muhammad Murtadha Othman, Ismail Musirin, Siti Zaliha Mohammad Noor. "Dynamic voltage restorer (DVR) in a complex voltage disturbance compensation", International Journal of Power Electronics and Drive Systems (IJPEDS), 2019

9 words — < 1%

Crossref

-
- 31 www.praiseworthyprize.org 9 words — < 1%
Internet
-
- 32 Ebrahim Babaei. "A new topology for dynamic voltage restorers without dc link", 2009 IEEE Symposium on Industrial Electronics & Applications, 10/2009 8 words — < 1%
Crossref
-
- 33 G. Venkata Suresh Babu, V. Ganesh. "Power quality enhancement in distributed energy resources by four leg voltage source converter", 2017 International Conference on Innovative Mechanisms for Industry Applications (ICIMIA), 2017 8 words — < 1%
Crossref
-
- 34 Jian Ye, Hoay Beng Gooi, Benfei Wang, Yuanzheng Li, Yun Liu. "Elliptical restoration based single-phase dynamic voltage restorer for source power factor correction", Electric Power Systems Research, 2019 8 words — < 1%
Crossref
-
- 35 Mohammad Farhadi-Kangarlu, Ebrahim Babaei, Frede Blaabjerg. "A comprehensive review of dynamic voltage restorers", International Journal of Electrical Power & Energy Systems, 2017 8 words — < 1%
Crossref
-
- 36 Ramasamy, M.. "Photovoltaic based dynamic voltage restorer with power saver capability using PI controller", International Journal of Electrical Power and Energy Systems, 201203 8 words — < 1%
Crossref
-
- 37 academicscience.co.in 8 words — < 1%
Internet
-

38 Internet 8 words — < 1%

39 jurnal.untan.ac.id Internet 8 words — < 1%

40 www.ijetae.com Internet 8 words — < 1%

41 www.ijirset.com Internet 8 words — < 1%

42 Reisi, Ali Reza, Mohammad H. Moradi, and Hemen Showkati. "Combined photovoltaic and unified power quality controller to improve power quality", *Solar Energy*, 2013.
Crossref 7 words — < 1%

43 Chang, G.. "An efficient power flow algorithm for weakly meshed distribution systems", *Electric Power Systems Research*, 201203
Crossref 6 words — < 1%

EXCLUDE QUOTES OFF

EXCLUDE SOURCES OFF

EXCLUDE BIBLIOGRAPHY ON

EXCLUDE MATCHES OFF